

TOMCAT

RIVAL

★ Handmade In USA - Since 1986 ★

Operator Manual (EN)

Models:
20" Disk

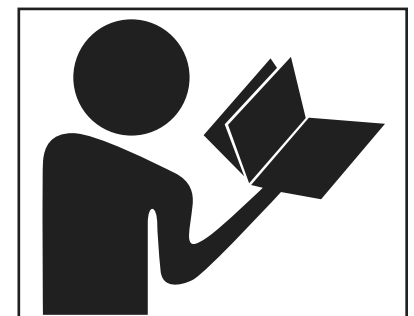
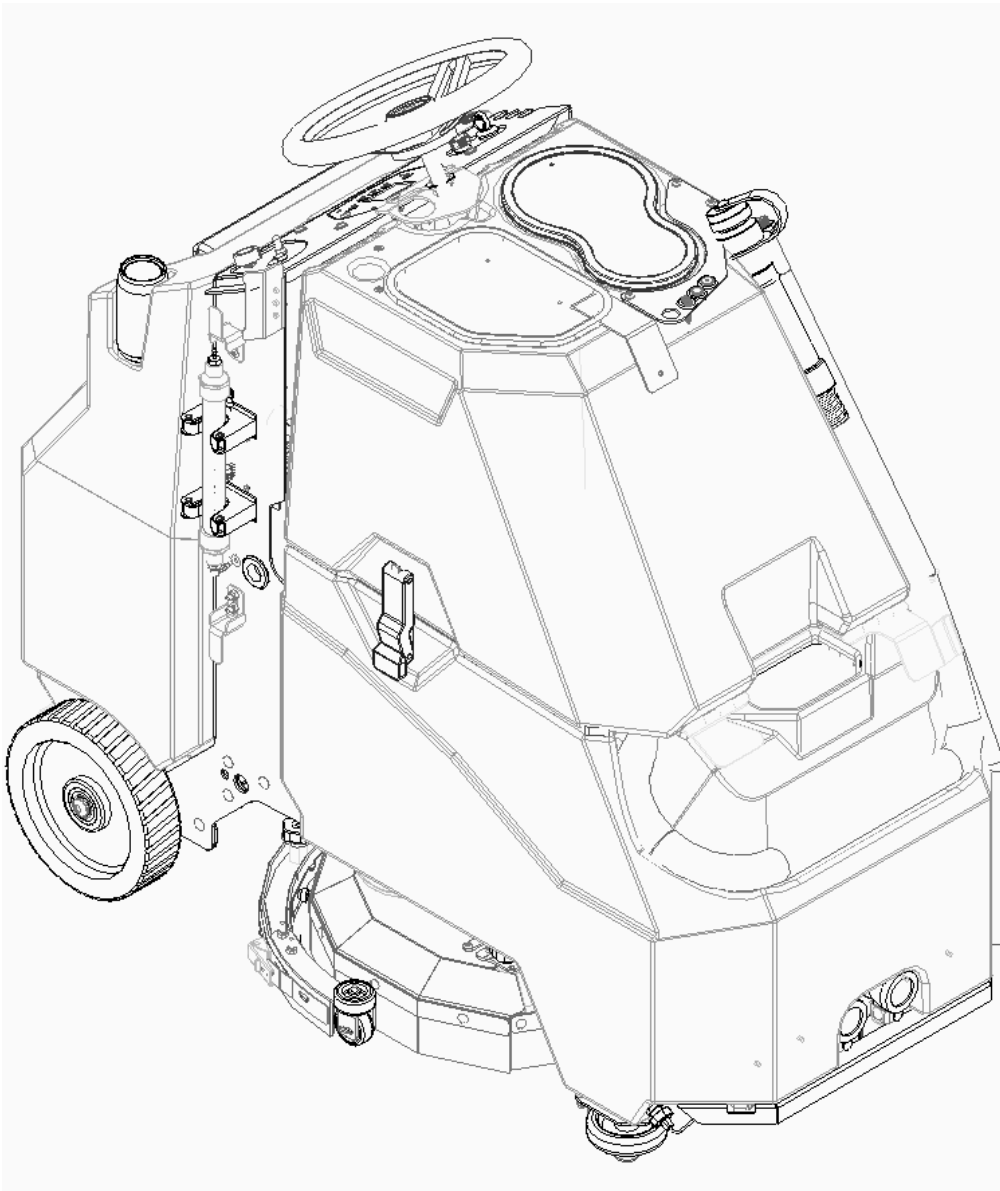

**Read the Operators Manual
before using the machine.**



**Read the Safety Messages
before servicing machine.**

www.tomcatequip.com
1711 South Street
Racine, WI 53404 (USA)
(800) 450-9824 | (+001) 262-681-6470
© 2026 RPS Corporation

V26.012
TC-STAND-UP-RIVAL-OP-EN

INTRODUCTION

This manual is furnished with each new machine. This manual will allow the Operator to get the best performance out of your RPS manufactured Scrubber-Drier, Sweeper, Burnisher, or Orbital Scrubber. Read this manual thoroughly before operating or servicing the machine.

This machine will provide excellent performance, but the best results will be obtained at the most minimum costs if:

- The machine is regularly maintained - per the Authorized Local Distributor.
- The machine is operated with reasonable care and caution.
- The machine is maintained with manufacturer supplied parts.

Locate Serial Number

The serial number of your machine is located on the lower half of the control panel of the machine.

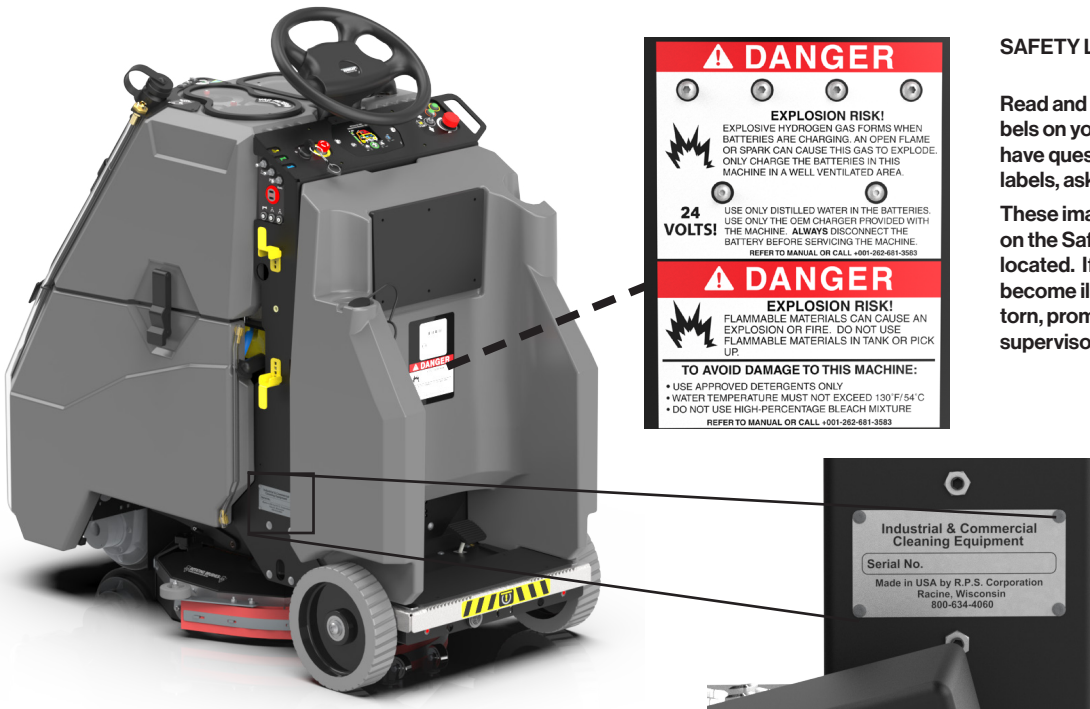

SAFETY LABELS

Read and obey all Safety Labels on your equipment. If you have questions about these labels, ask your supervisor.

These images indicate where on the Safety Labels are located. If ever the labels become illegible, worn off, or torn, promptly report it to your supervisor and replace it.

AS OUR POLICY IS ONE OF CONSTANT IMPROVEMENT - ALL INFORMATION AND SPECIFICATIONS ARE SUBJECT TO CHANGE WITHOUT NOTICE.

Intended use

The Tomcat Rival Stand On Floor Scrubber is intended for commercial applications with hard floor surfaces such as concrete, VCT, tile and grout, stone, ect. This machine is not designed to clean carpets or sand wooden surfaces. Use only OEM pads/brushes and commercially available floor cleaning detergents. Do not use this machine other than described in this Operator Manual.

Machine Data

Fill out while installing machine for future reference.

Model No. - _____

Serial No. - _____

Installation Date - _____

Uncrating Machine

Inspect machine for damage before unloading, if any damage has occurred report it to the carrier. Contact distributor or RPS Corp. for missing components.

Remove protective shipping frame then locate and unscrew the metal bracket connecting the machine to the pallet. Before removal the scrub head should be in the raised position. Using the supplied ramp carefully back the machine off the pallet.



INTRODUCTION

Intended use 2
Machine Data 2
Uncrating Machine 2

SAFETY

Important Safety Messages 4
Safety Labels 5

OPERATION

Machine Overview 6
Central Command Overview 7
Membrane Icons 8
Parking Brake 9
Steering Controls 10
Battery Setup 11
Charging 12
Squeegee Installation 13
Squeegee Adjustment 14
Forward Drive 15
Reverse Drive 16
Fill Solution Tank 17
Scrubbing & Drying 18
Drain & Flushing Recovery - Drain Saver 19
Headlights (Optional) 20
Spray Jet Controls (Optional) 21
Filling Disinfectant Tank (Optional) . . . 22
ZERO3 Controls (Optional) 23
Utility Bracket (Optional) 24
Charge Batteries 25

WEEKLY MAINTENANCE (OR 25 HRS)

Clean White Filter/Screen 26
Check Brush 27
Check Pad 28
Rotate Squeegee Blade 29
Check ZERO3 Air Dryer(Optional) 30
Clean Solution Filter 31
Clean Spray Pump Filter 32
Drain Solution Tank 33

MONTHLY MAINTENANCE (OR 100 HRS)

Adjusting Deck Curtains 34
Battery Water Level 35

OTHER

PM Sheet 36
Battery Chargers 38





ERROR CODES

Membrane 39
Membrane 40

SAFETY

Important Safety Messages

You will see four kinds of safety reminders in this manual:

 DANGER DANGER indicates a hazardous situation which, if not avoided, will result in death or serious injury.	 WARNING WARNING indicates a potentially hazardous situation which, if not avoided, could result in death or serious injury.
 CAUTION CAUTION indicates a potentially hazardous situation which, if not avoided, could result in minor or moderate injury or damage to this machine or nearby objects. CAUTION also can be used to alert against unsafe practices.	 NOTICE NOTICE indicates information considered important, but not hazard-related. This safety message may be related to property damage or warranty warnings.

Your safety, and that of others, is very important. Operating this machine safely is an important responsibility.

DO NOT OPERATE THIS MACHINE:

- Unless you are trained and authorized to do so by your RPS Authorized Local Distributor
- Unless you have read and understood this Operator's Manual
- On surfaces with greater than a 3° slope.
- Within 25' (8m) of Loading Docks

WHEN OPERATING THIS MACHINE:

- Remove loose objects from the floor that could be projected from the rotating Brushes
- Keep your hands and feet away from the rotating Brushes
- Do not operate this machine where flammable liquids, vapors, or dust are present
- Use caution when maneuvering



BEFORE LEAVING THE MACHINE:

- Drain "clean" Solution & "dirty" Recovery solution into APPROVED drains
- Park the machine on a level surface
- Turn the machine off & remove key

BEFORE SERVICING THE MACHINE:

- Disconnect the Batteries
- Wear PPE



 DANGER Explosive hydrogen gas forms when Batteries are charging. An open flame or spark can cause this gas to explode. Serious personal injury or property damage could occur. Only charge the Batteries in this machine in a well ventilated area.	 DANGER Flammable materials can cause an explosion or fire. Do not use flammable materials in Tank or pick up.
---	---

! WARNING

The Batteries in this machine produce hazardous voltage which can cause electrical shock, burns and/or electrocution. Always disconnect Batteries before servicing this machine.

! WARNING

When climbing or descending ramps, always drive machine forward. To avoid overturning the machine, Do not back down ramps. Do not drive across inclines. Do not turn while ascending or descending ramps. Overturning the machine can cause serious injury or death.

! WARNING

Do not use water that exceeds 135°F / 57°C. If water is above said temperature, this will void the Tank Warranty.

! WARNING

Do not park this machine on ramps or slopes. Always park this machine on a level, hard surface. Do not operate this machine outdoors or on uneven surfaces.

! WARNING

The Batteries in this machine contain sulfuric acid, which causes burns to skin. If battery acid contacts clothing or skin, rinse the effected area with cold water immediately. If battery acid gets on your face or in your eyes, flush the area immediately with cold water and seek medical attention.

! WARNING

To avoid electrical shock, do not operate this machine over electrical floor outlets.

! CAUTION

To avoid damage to this machine, use only cleaning solutions and replacement parts recommended by the manufacturer.

! CAUTION

Do not operate this machine if any parts have been damaged or removed.

! WARNING

Dress safely. Do not wear rings or metal wrist watches when servicing this machine, as they can cause an electrical short circuit which can cause serious burns.

! WARNING

Do not remove, paint over or destroy warning decals. If warning decals become damaged, call 1-262-681-3583 for free replacements.

! WARNING

Dress safely. Do not wear a neck tie, scarf, or any loose or dangling clothing while operating this machine. Loose or dangling clothing or neck-wear can tangle in rotating parts, causing serious injury or death.

! WARNING

Always turn off this machine before leaving it unattended. Do not allow untrained persons to operate this machine.

! WARNING

NO RIDERS. Do not carry passengers on this machine. Do not use this machine as a stepladder or work platform.

! WARNING

Understand the dynamic braking system before you operate the machine on ramps. Machine may coast.

! WARNING

Before you service a Battery, always wear face protection, protective gloves and protective clothing. Battery acid or battery explosion can cause serious injuries.

! CAUTION

Always use the automatic battery charger provided by the manufacturer of this machine to charge the Batteries of this machine. It is designed to charge the Batteries at the appropriate rate. If you must use a different charger, disconnect the Batteries before charging to avoid damage to the electronic speed controller.

! CAUTION

To avoid damage to the electronic control components of this machine, Do not store this machine outdoors. Do not pressure wash this machine.

OPERATION

Machine Overview

1. Recovery Tank
2. Solution Tank
3. Batteries (24vdc System)
4. Dashboard
5. Steering Wheel
6. Foot Pedal
7. Electrical Panel
8. Vac Motor
9. Squeegee
10. Rear Wheels
11. Front Wheel Drive + Parking Brake
12. Recovery Tank Lid
13. Foam Float Ball & White Vac Filter
14. Hose Bracket
15. Squeegee Hose
16. Tank Latch
17. Solution Fill Port / Remote Fill Hose
18. Charger
19. Solution Sight Tube
20. Recovery Drain Hose
21. Scrub Deck
22. Disinfectant fill port
23. Operator Presence Plate
24. Hip Pad
25. Headlights
26. Charger AC Cord Wrap



Central Command Overview

1. Full Recovery Tank Red Indicator
2. Empty Solution Tank Yellow Indicator
3. Vac Clog Indicator
4. Solution Flow Indicator (1, 2, 3)
5. Down Pressure Gauge (1, 2, 3)
6. Vac Switch On-Off (Hold Econ)
7. Solution/Scrub/Vac Easy Button On-Off
8. Scrubdeck Switch On-Off (Hold +/- Pressure)
9. 2 Sec symbol, hold for secondary operations
10. Technician View
11. Solution On-Off (Hold +/- 1, 2, 3)

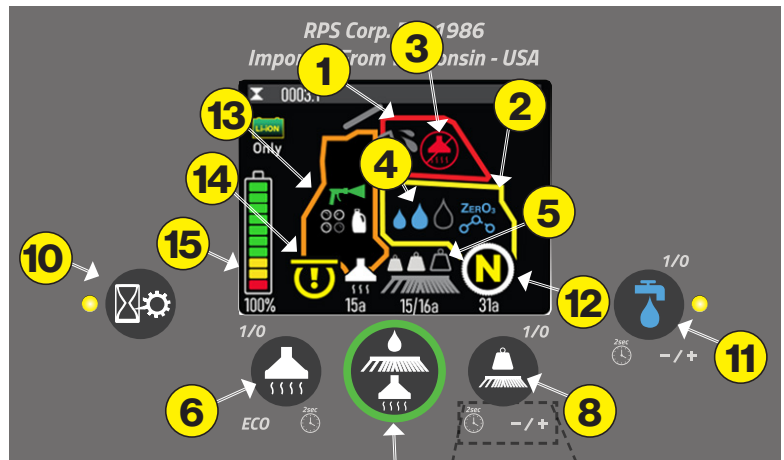

Quick Press On/Off.
Hold for 2nd feature.

12. Neutral/Forward/Reverse Indicator
13. Empty Disinfectant Tank Orange Indicator
14. Operator Presence Indicator
15. Battery Indicator
16. Drive Position
17. Neutral Position
18. Reverse Positions
19. Horn
20. Headlight Flasher (Optional)
21. Speed Potentiometer
22. Key Switch On (I) / Off (O)
23. E-stop
24. Headlights on / off
25. Disinfectant Spray Toggle
26. ZERO3
27. Dual USB
28. Negative Busbar CB
29. Positive Busbar CB
30. Spray Gun Toggle CB

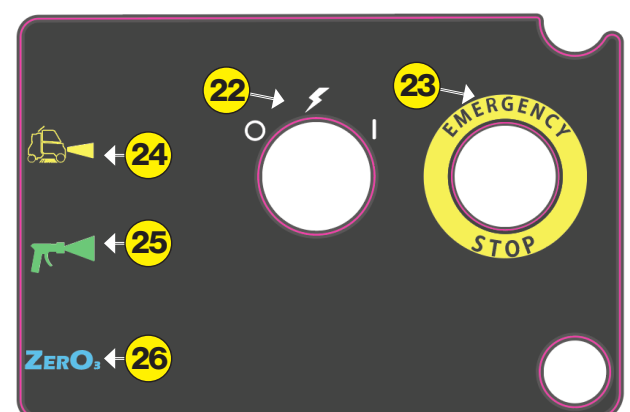
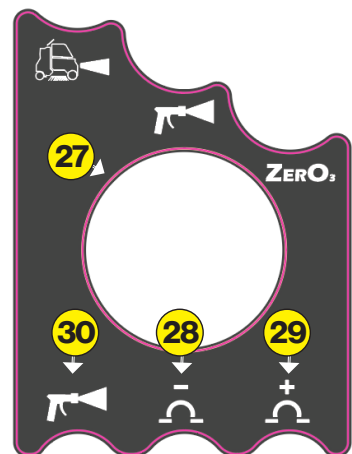
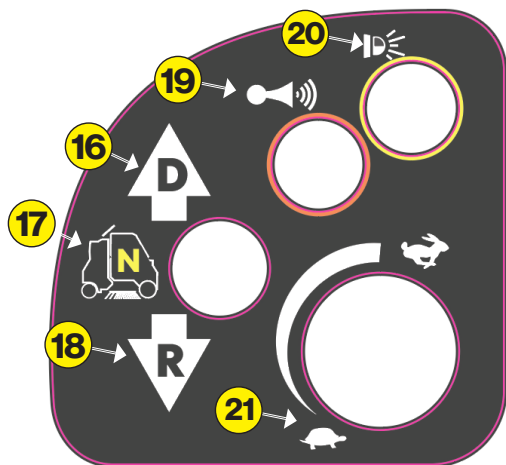

OPERATION

Membrane Icons

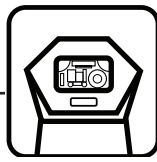

1. TECHNICIAN SCREEN
2. ACTIVE VOLT & AMP DRAW
3. OPERATOR PRESENCE PLATE
4. VAC CURRENT (AMPS)
5. BRUSH DISK CURRENT (AMPS ACTUAL / TARGET)
6. TRANSPORT CURRENT (AMPS)
7. HOUR METERS (VAC, SCRUB, TRANSPORT)

Li-ion

Only

7

SETTINGS SCREEN

BATTERY

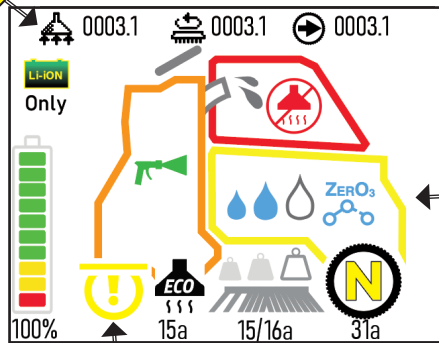

2

3

4

5

6

TRACTION FORWARD

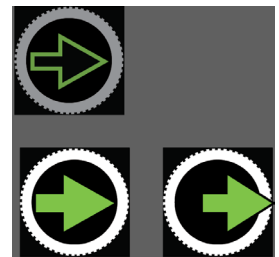

VAC (I/O)



VAC ECO 75%



SCRUB PRESSURE

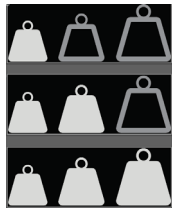

BRUSH (I/O)



WATER (0, 1, 2, 3)



TRACTION REVERSE

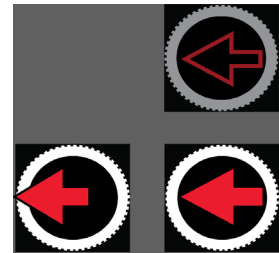

NEUTRAL

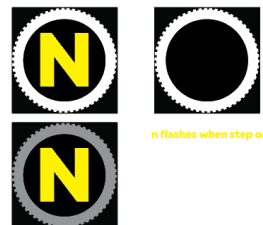



! WARNING
Do not park this machine on ramps or slopes. Always park this machine on a level, hard surface. Do not operate this machine outdoors or on uneven surfaces.

! WARNING
Understand the dynamic braking system before you operate the machine on ramps. Machine may coast.

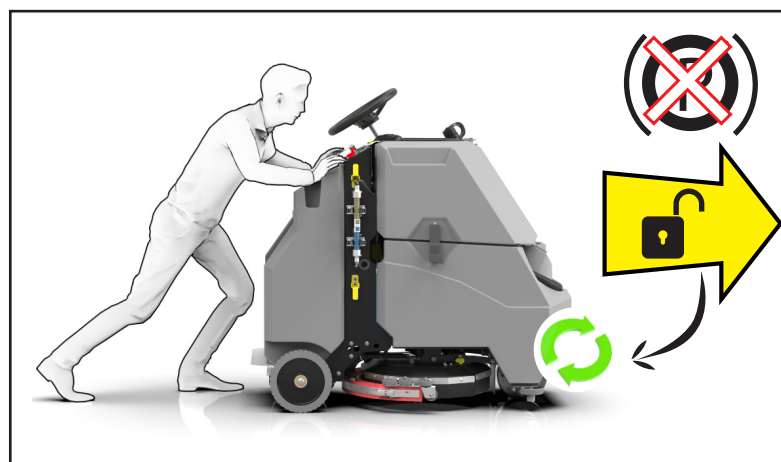
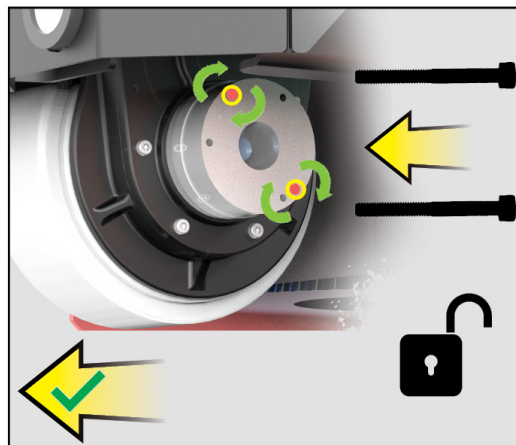
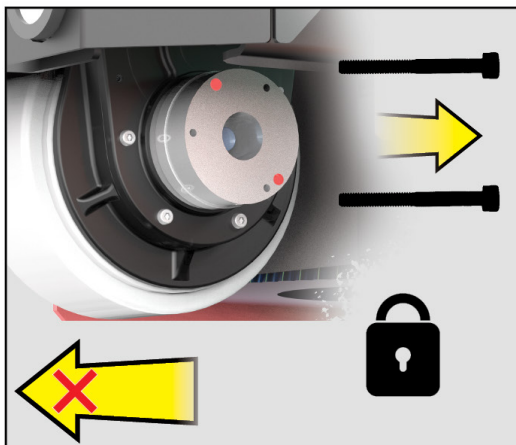

OPERATION

Steering Controls

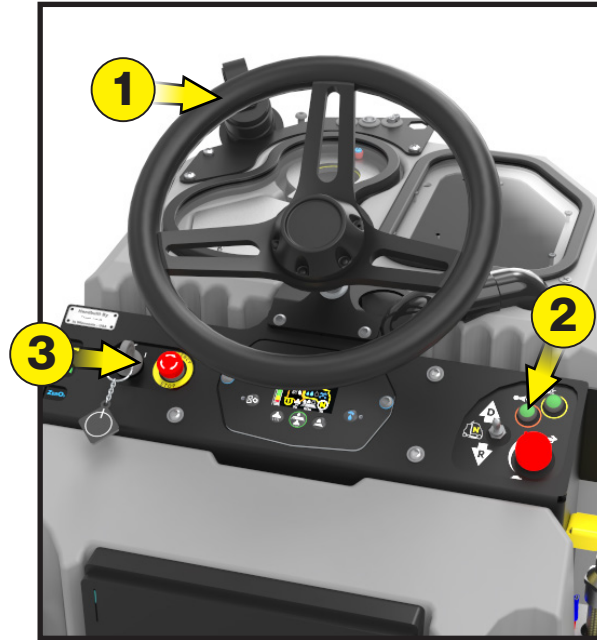

1. A diagram showing a steering wheel with dashed lines and arrows indicating its range of motion. The left side shows the wheel turning left, and the right side shows it turning right, separated by a vertical dashed line.	2. A black silhouette of a horn with sound waves emanating from it.	3. A black silhouette of a hand pressing down on a button. To the right of the icon, the text "EMERGENCY STOP" is written in bold, uppercase letters.
--	---	---

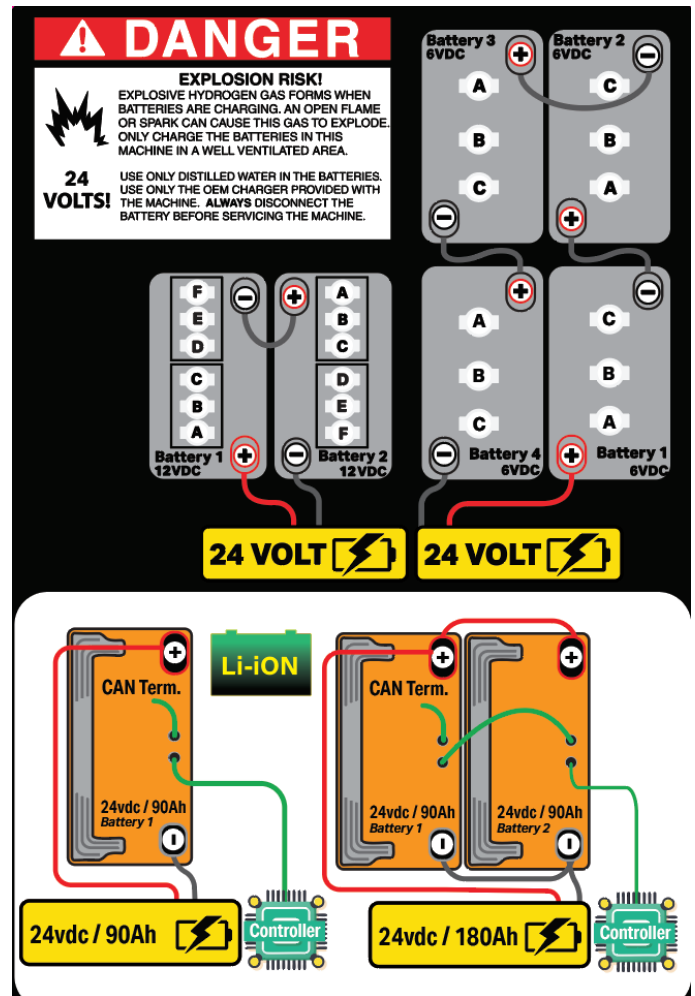
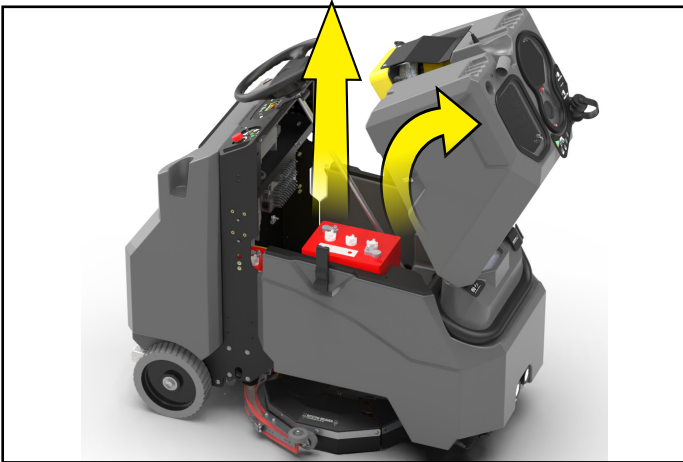
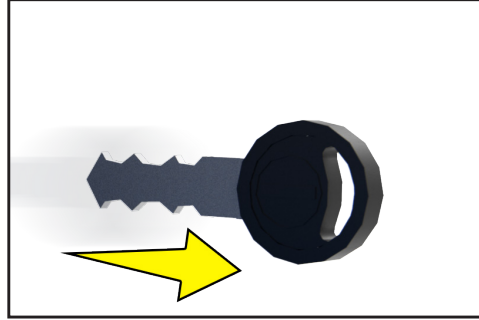
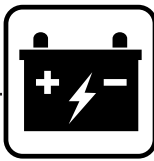

Torque Settings:
8-12 ft/lbs (10.8 - 16.3 Newton-meters)

NOTICE

Batteries are a possible environmental hazard. Consult your Battery supplier for safe disposal methods.

⚠ WARNING

Before you service a Battery, always wear face protection, protective gloves and protective clothing. Battery acid or battery explosion can cause serious injuries.



⚠ WARNING

The Batteries in this machine contain sulfuric acid, which causes burns to skin. If battery acid contacts clothing or skin, rinse the effected area with cold water immediately. If battery acid gets on your face or in your eyes, flush the area immediately with cold water and seek medical attention.

OPERATION

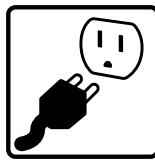

Charging

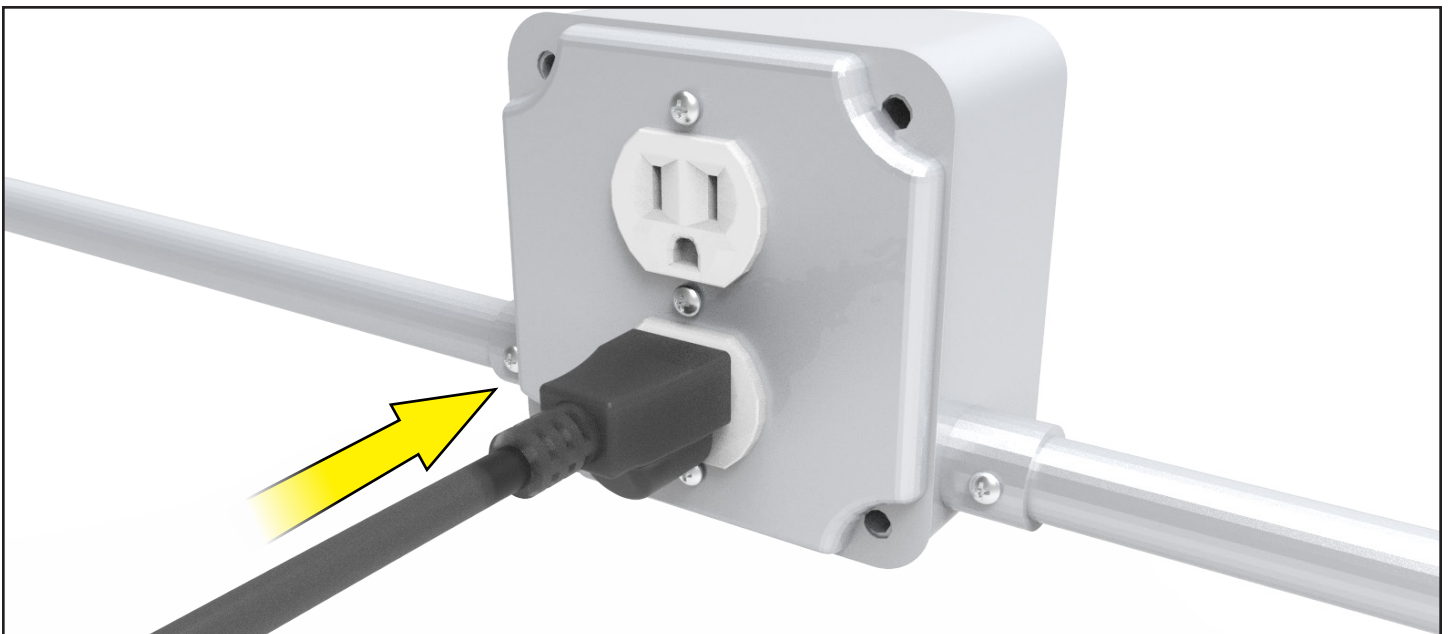
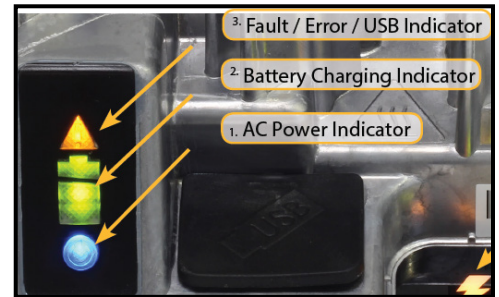
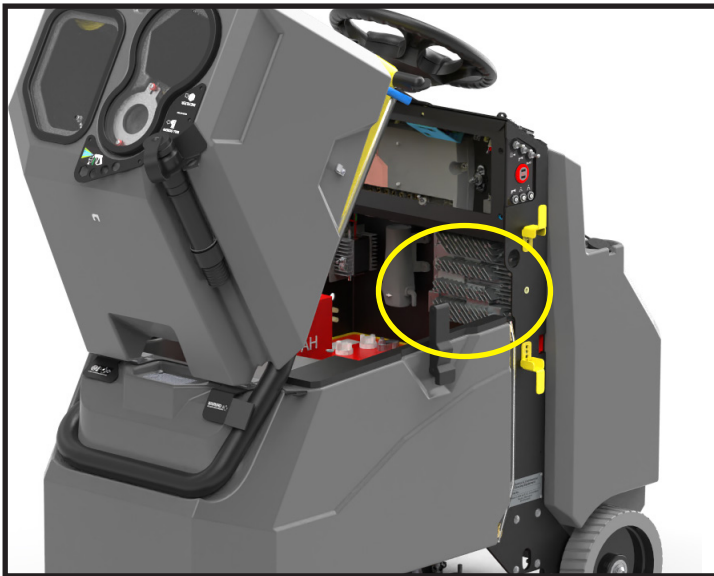
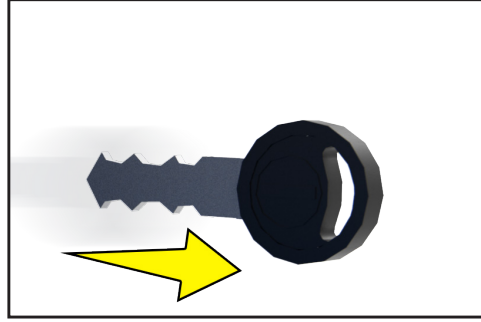

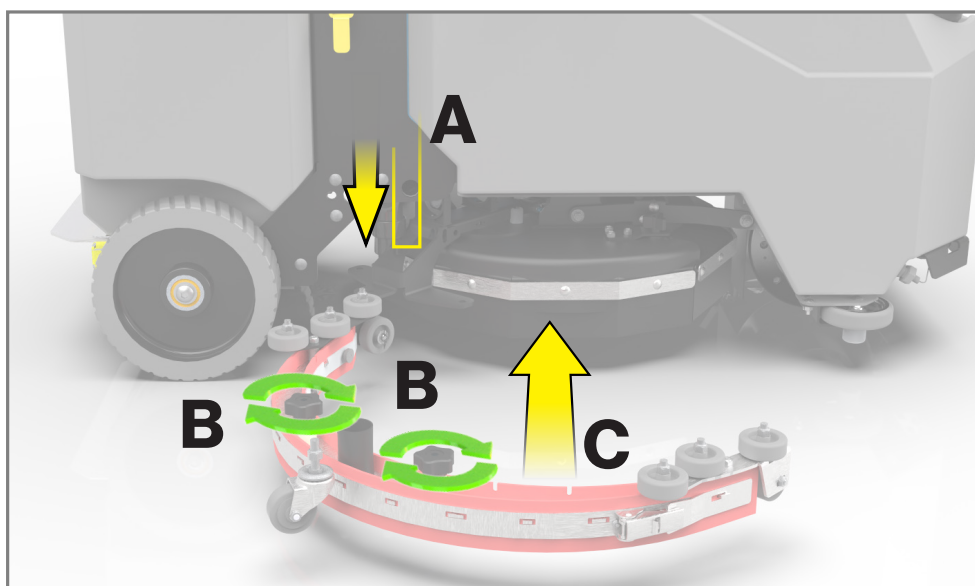
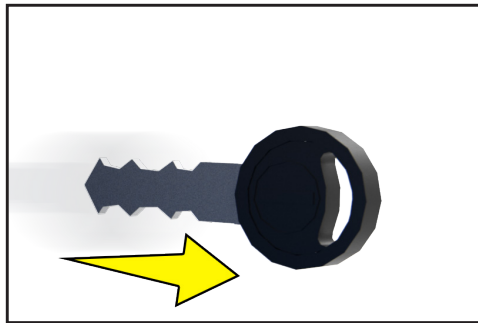

OPERATION

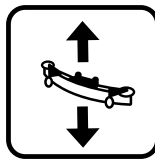

Squeegee Adjustment

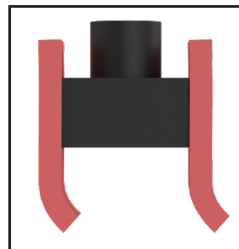
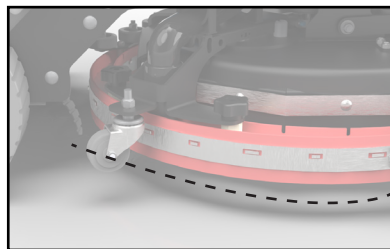
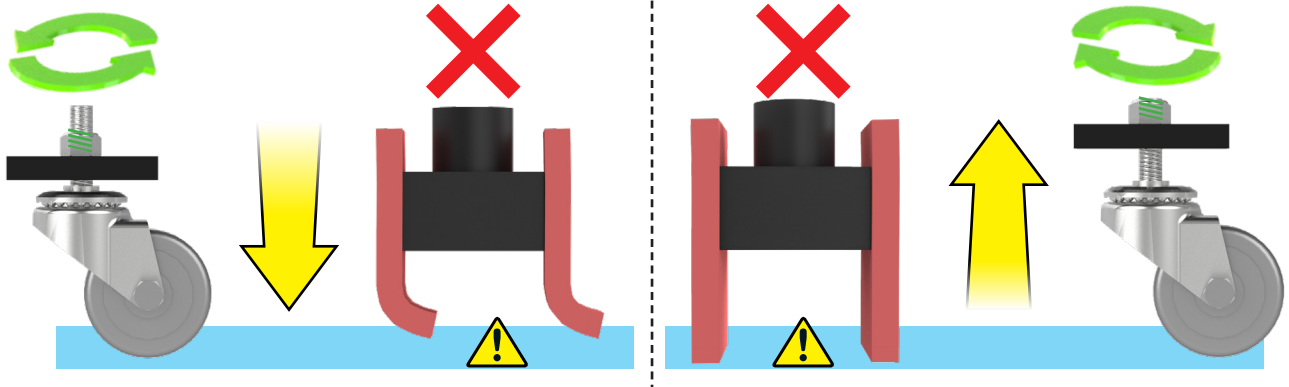
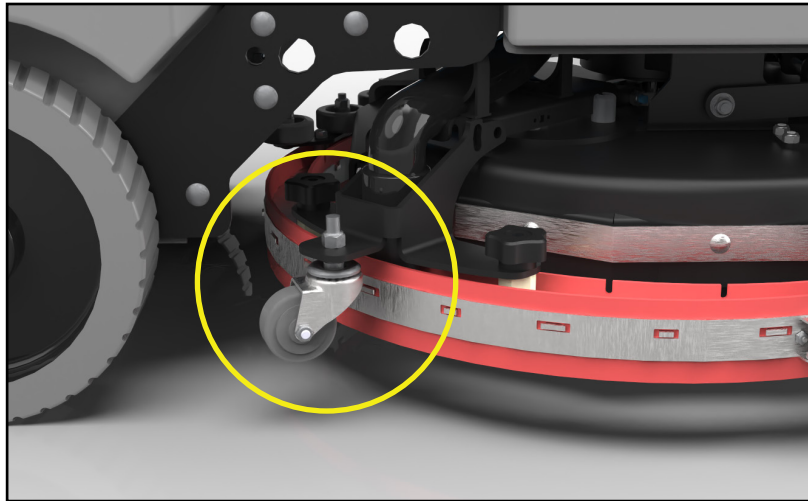
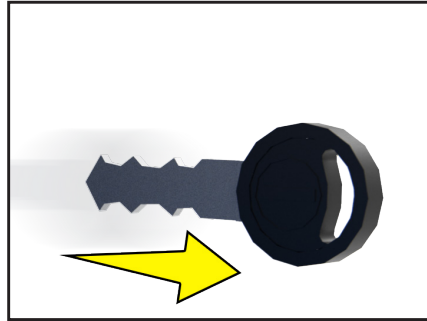



OPERATION

Forward Drive

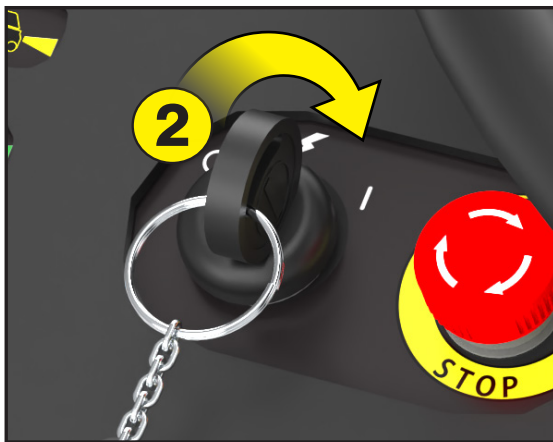
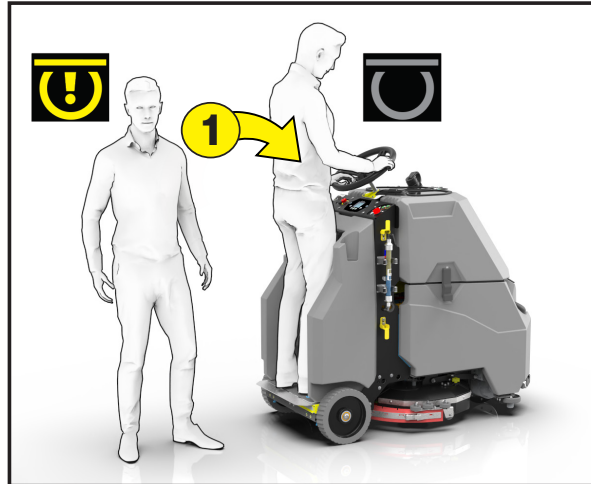

Wait 5 sec

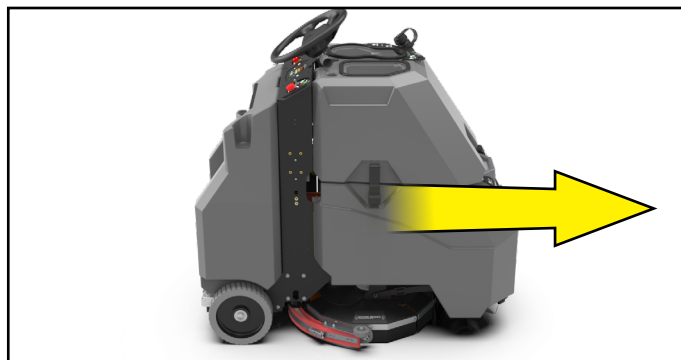
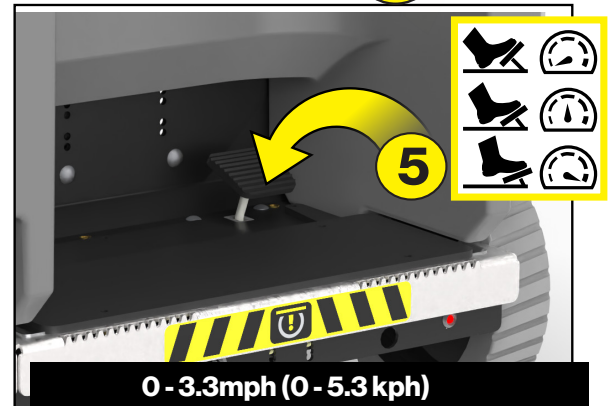
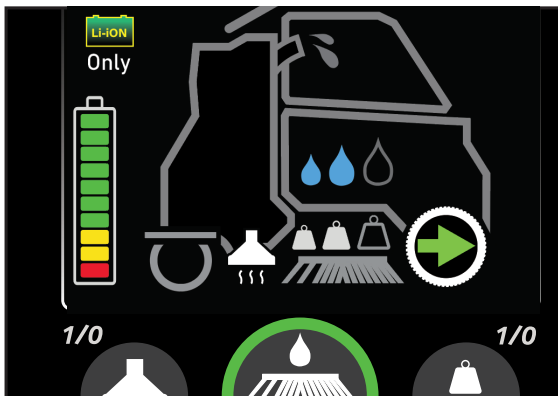
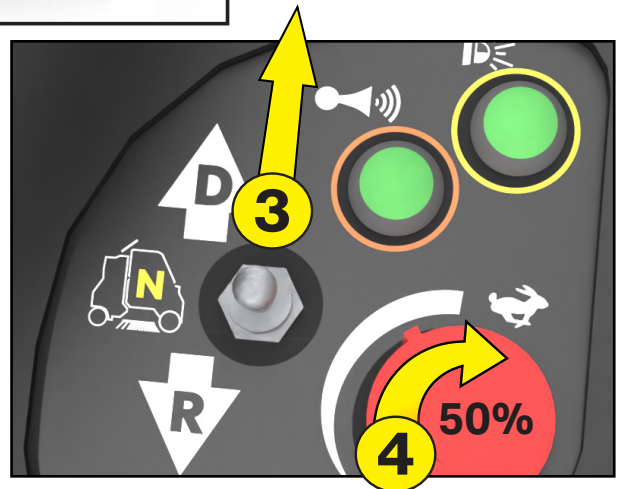

OPERATION



Reverse Drive

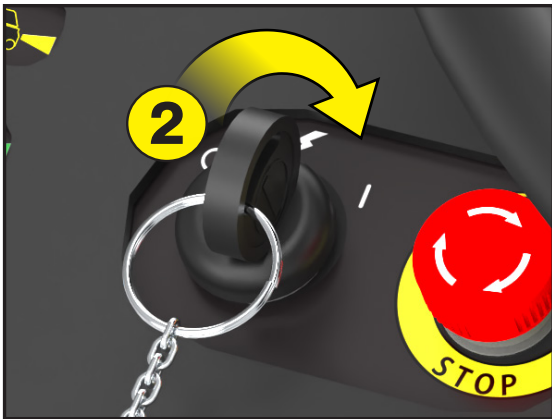
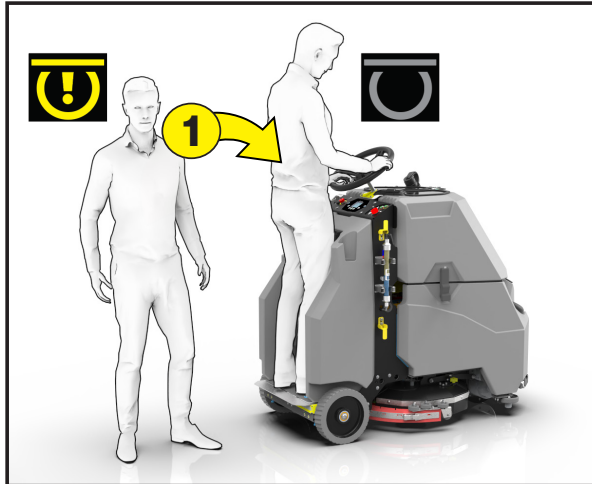

Wait 5 sec

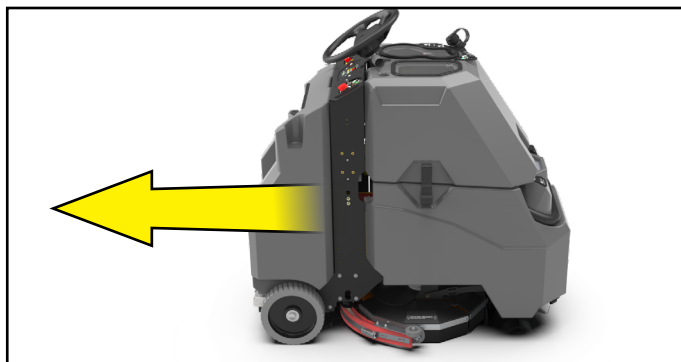
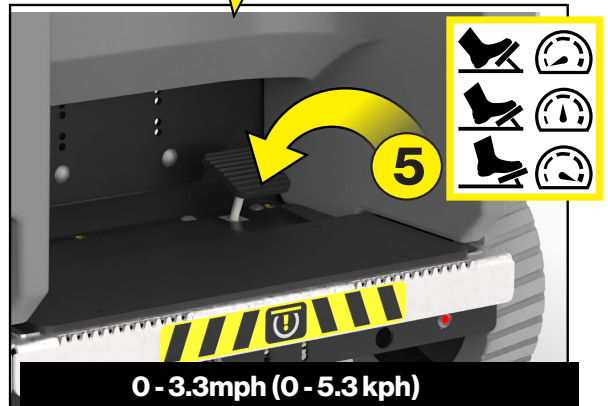
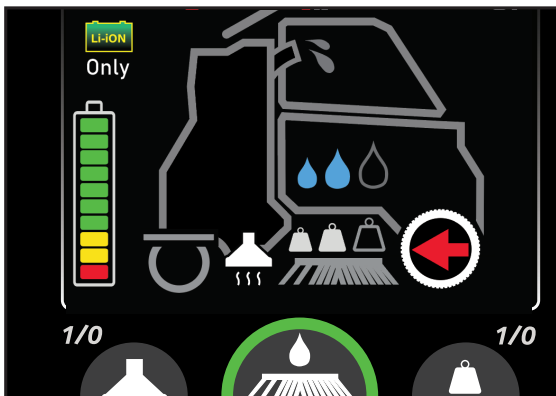
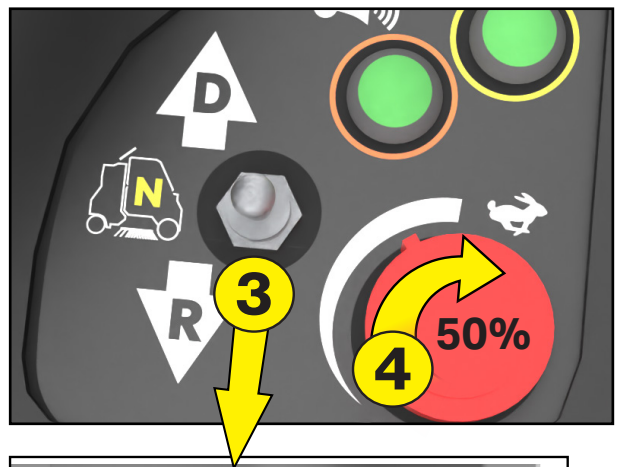

< 130° F 54° C

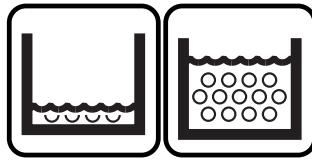

OPERATION

Fill Solution Tank

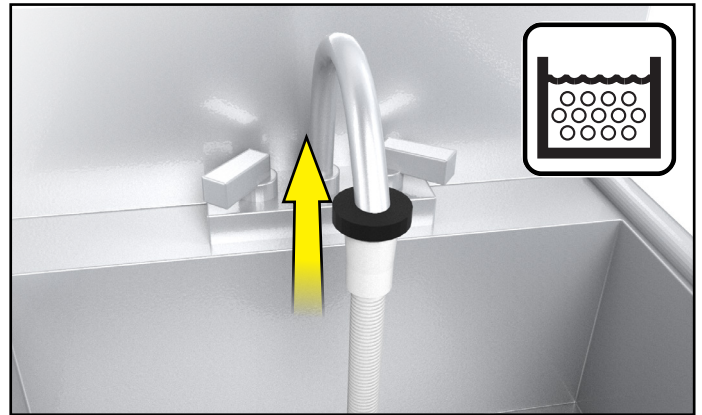
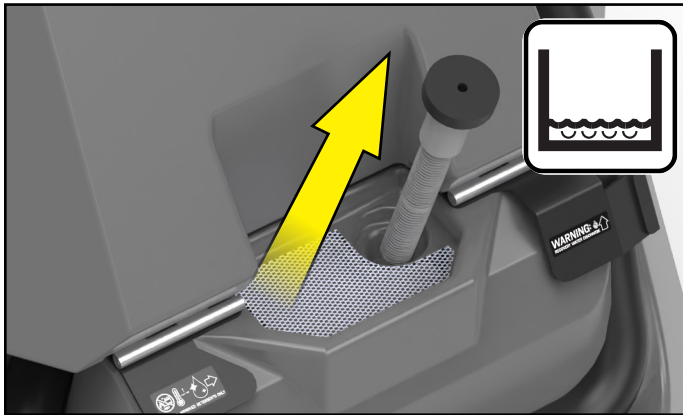
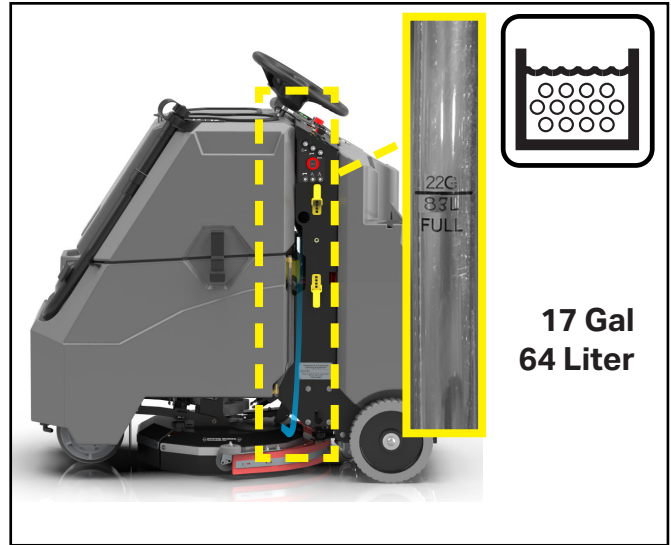
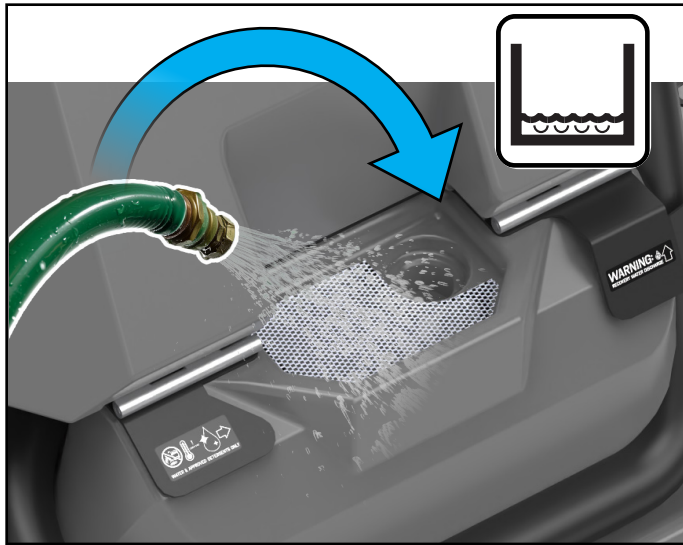

! DANGER

EXPLOSION RISK!
FLAMMABLE MATERIALS CAN CAUSE AN EXPLOSION OR FIRE. DO NOT USE FLAMMABLE MATERIALS IN TANK OR PICK UP.

TO AVOID DAMAGE TO THIS MACHINE:

- USE APPROVED DETERGENTS ONLY
- WATER TEMPERATURE MUST NOT EXCEED 130° F / 54° C
- DO NOT USE HIGH-PERCENTAGE BLEACH MIXTURE

REFER TO MANUAL OR CALL +011-262-681-3583

OPERATION



Scrubbing & Drying

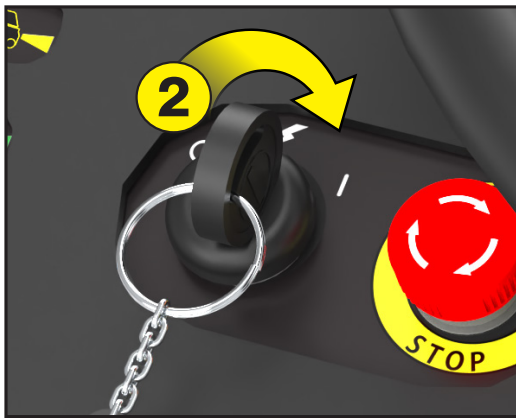
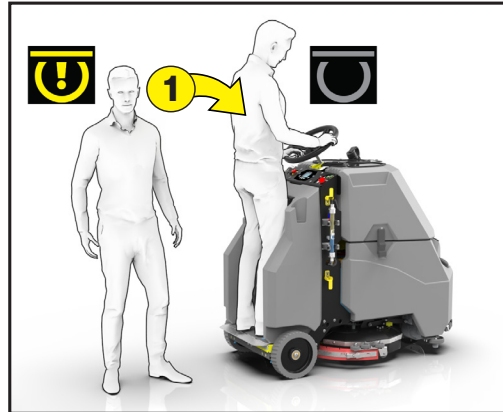

Wait 5 sec

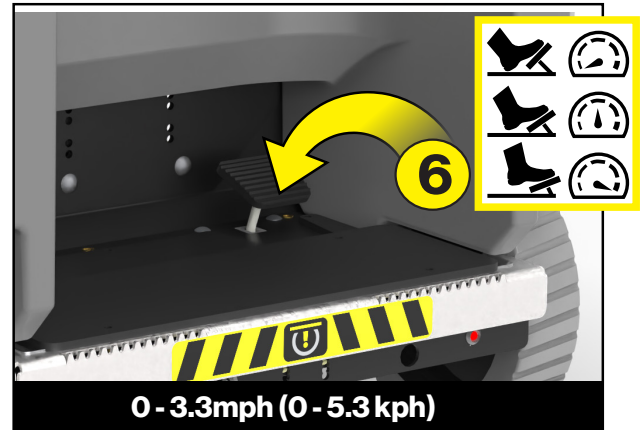
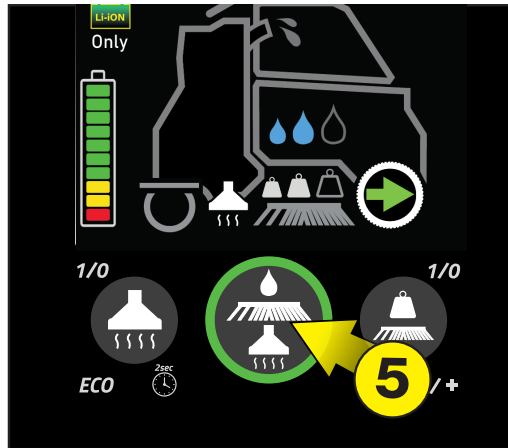
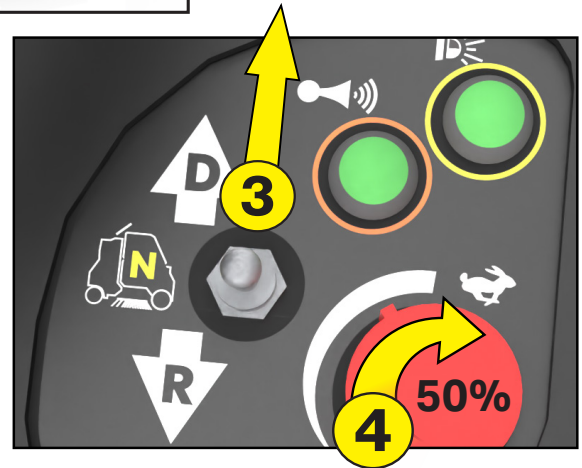

0 - 3.3mph (0 - 5.3 kph)

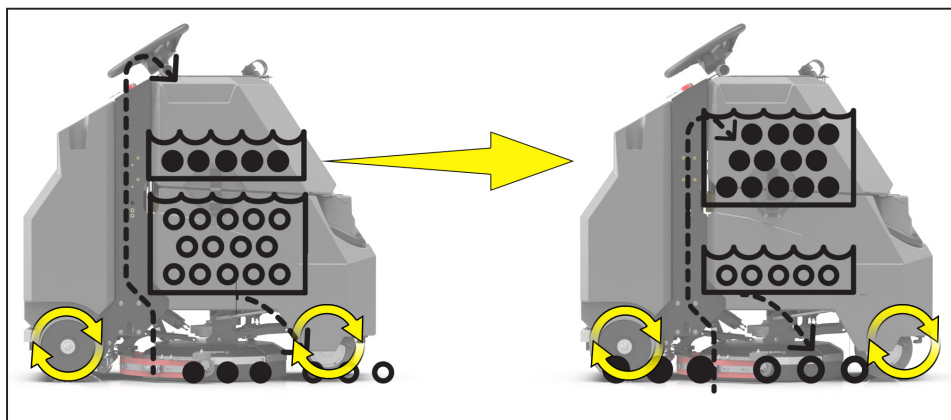

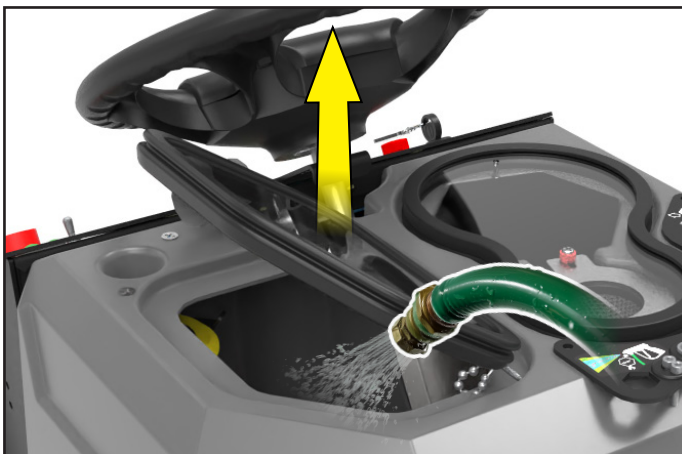
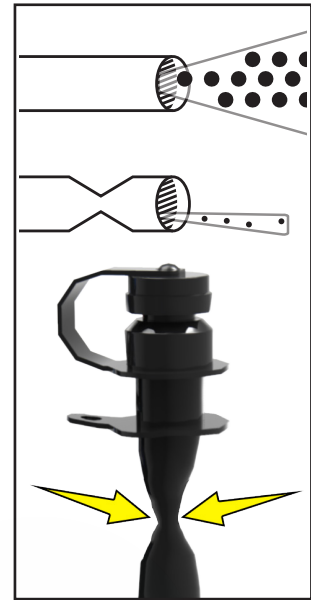
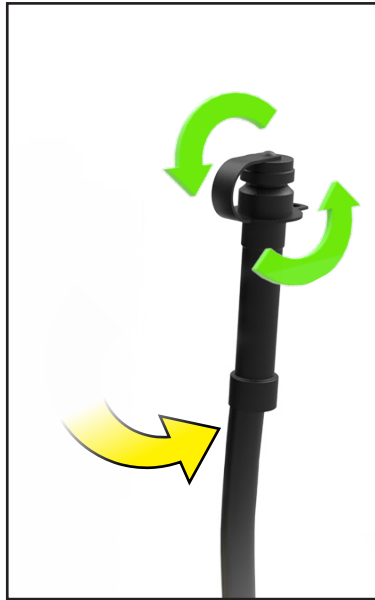
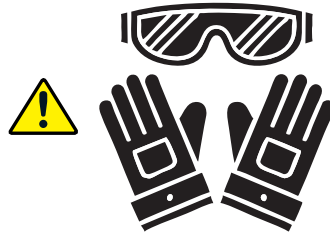

NOTICE
Drain "clean" Solution & "dirty" Recovery solution into APPROVED drains

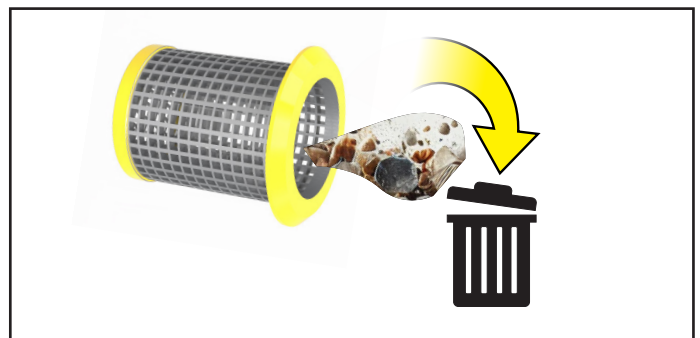
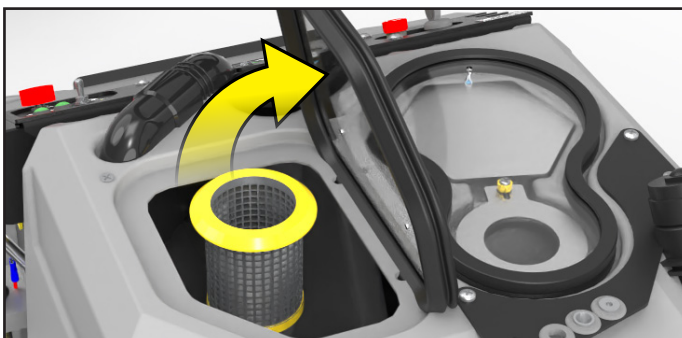

OPERATION

Headlights (Optional)

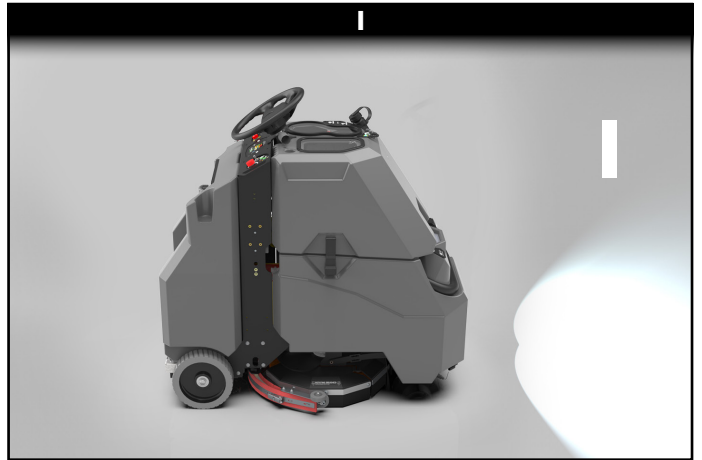
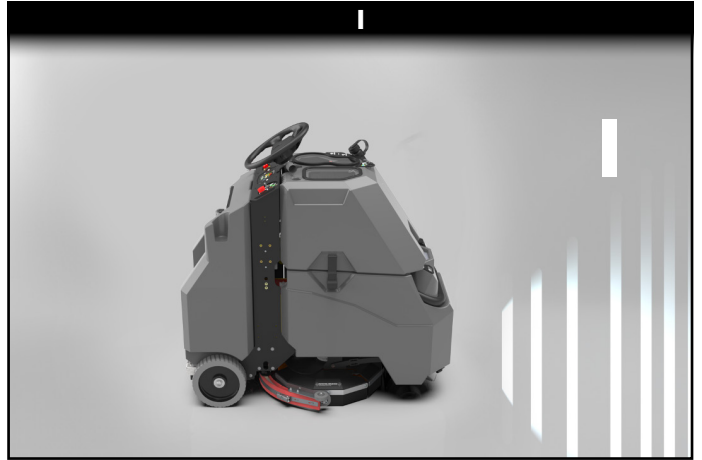

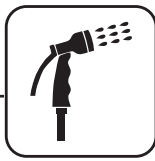

Dedicated Disinfectant Tank

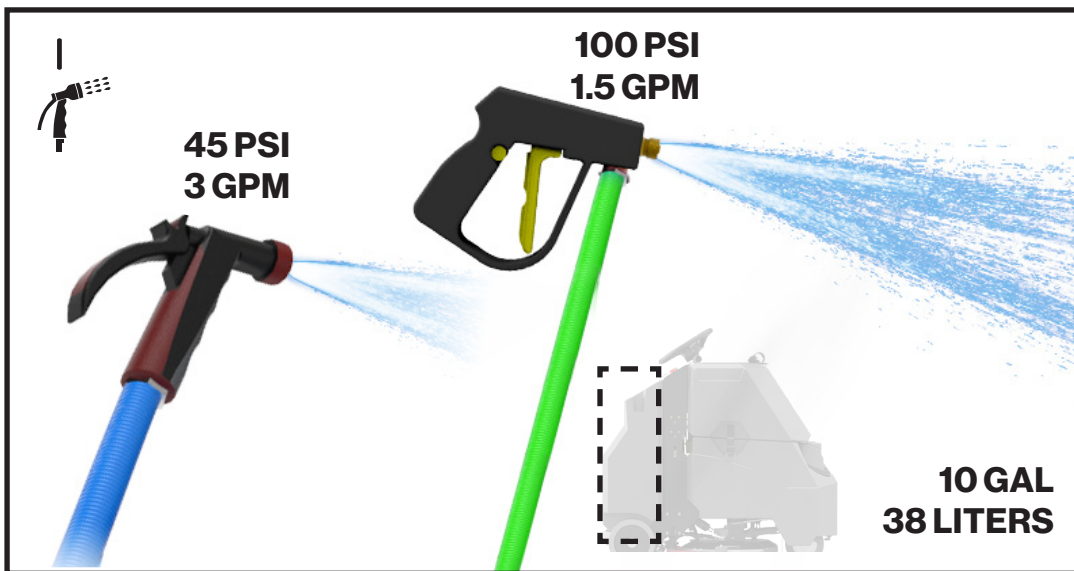

OPERATION

Filling Disinfectant Tank (Optional)



< 130° F 54° C



⚠ DANGER

EXPLOSION RISK!
FLAMMABLE MATERIALS CAN CAUSE AN EXPLOSION OR FIRE. DO NOT USE FLAMMABLE MATERIALS IN TANK OR PICK UP.

TO AVOID DAMAGE TO THIS MACHINE:

- USE APPROVED DETERGENTS ONLY
- WATER TEMPERATURE MUST NOT EXCEED 130° F/54° C
- DO NOT USE HIGH-PERCENTAGE BLEACH MIXTURE

REFER TO MANUAL OR CALL +011-262-681-3583



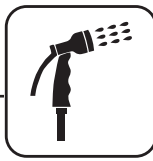

OPERATION

ZERO3 Controls (Optional)

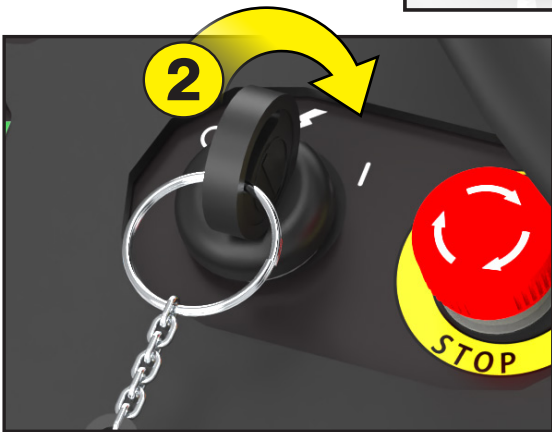
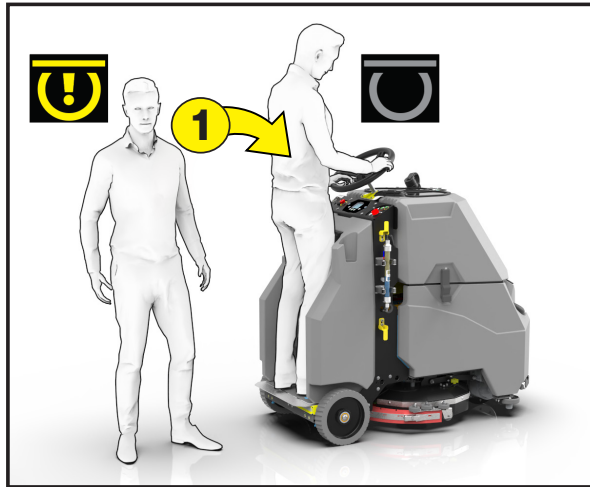

Wait 5 sec

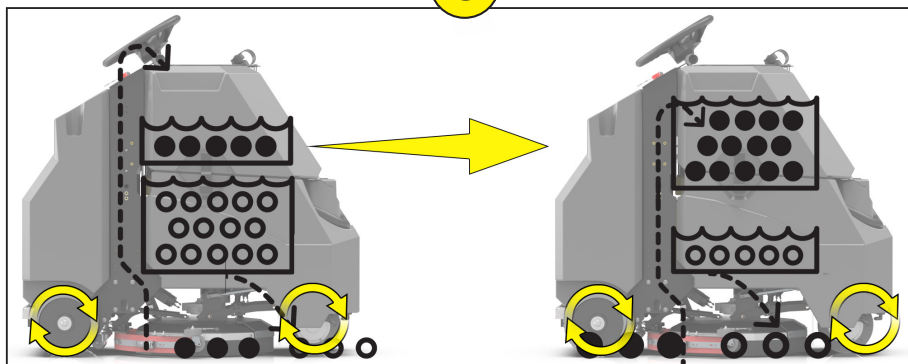
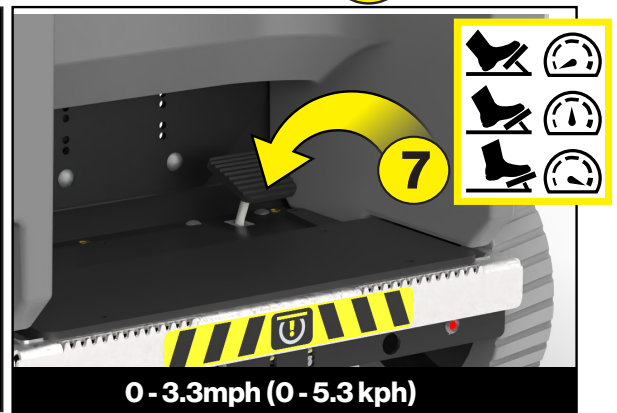
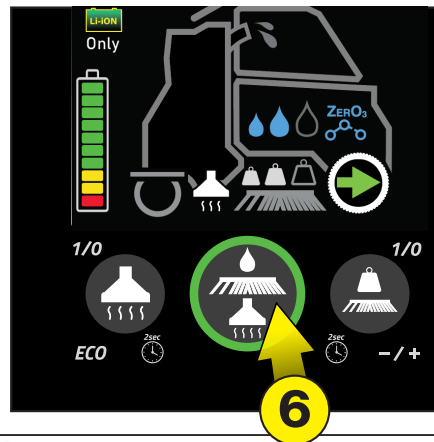
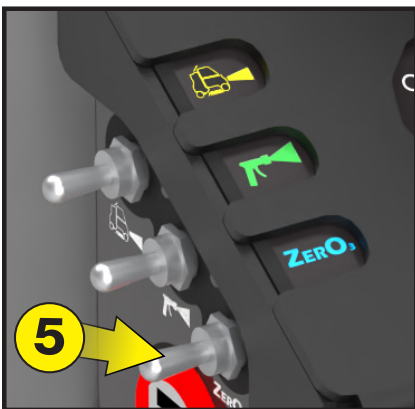
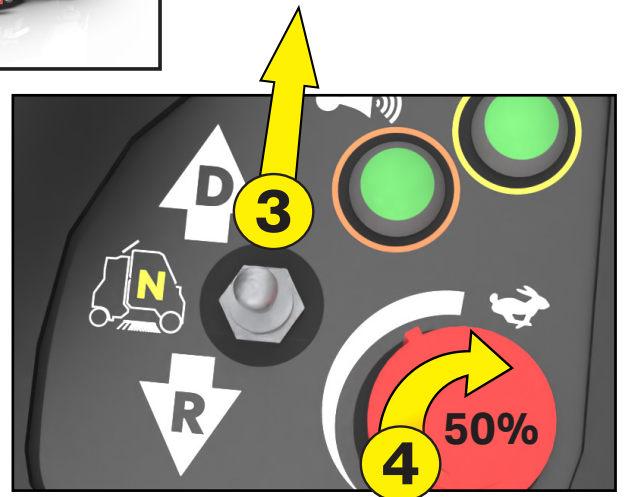

OPERATION

Utility Bracket (Optional)

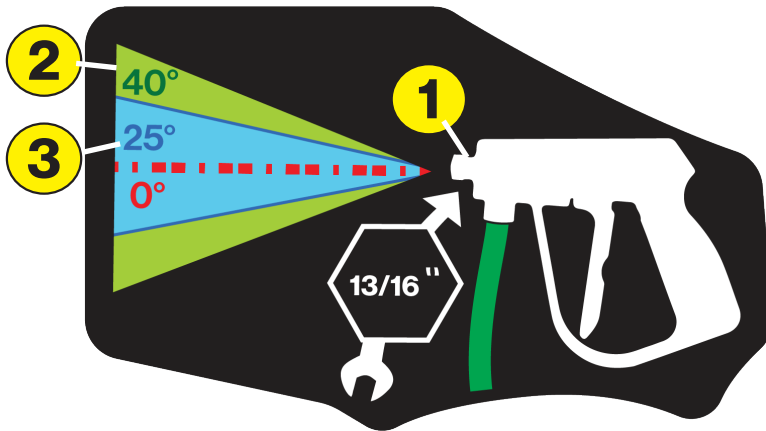
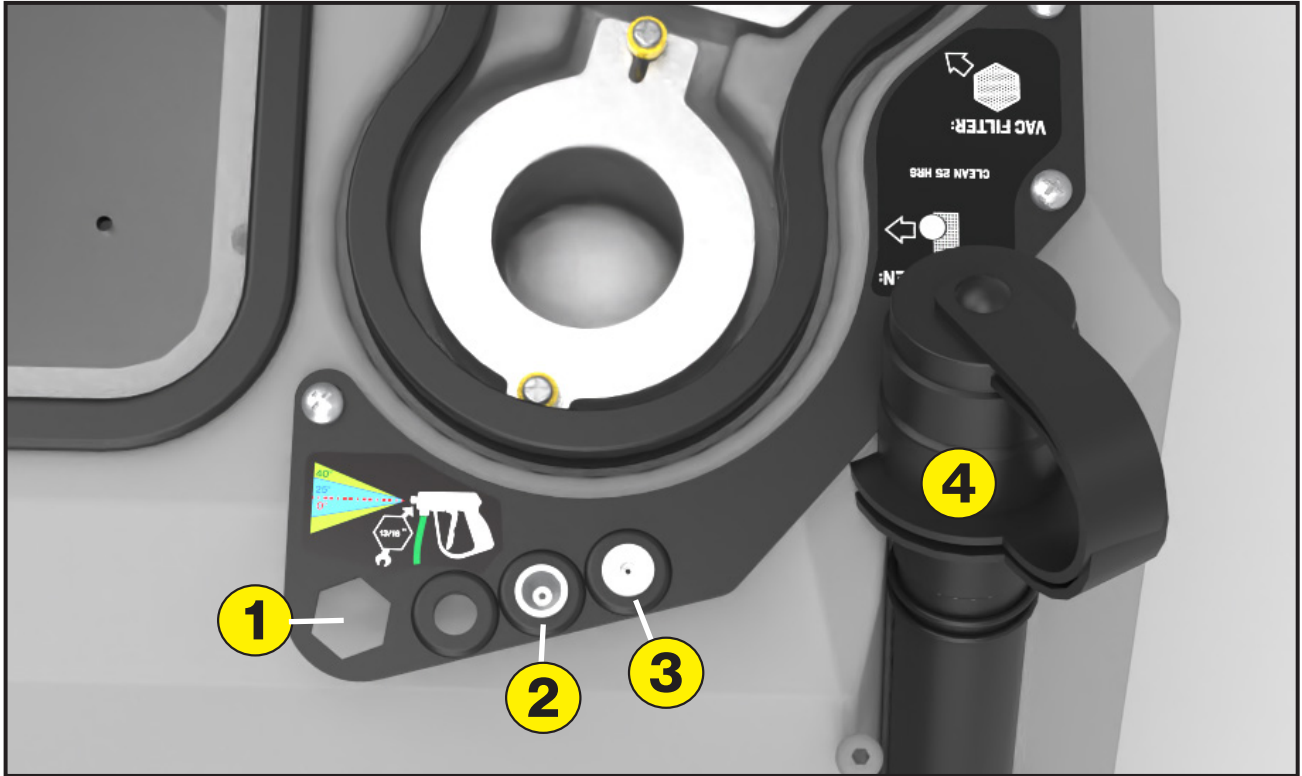

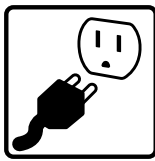

DAILY MAINTENANCE

Charge Batteries

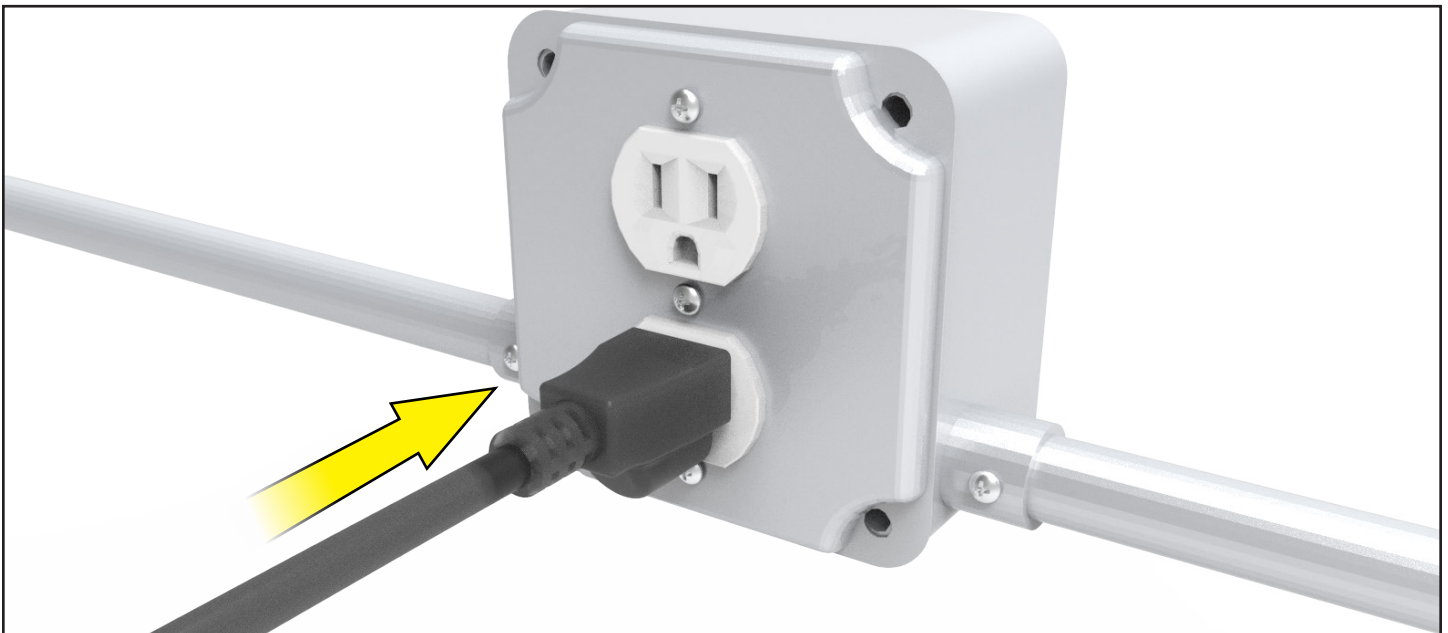
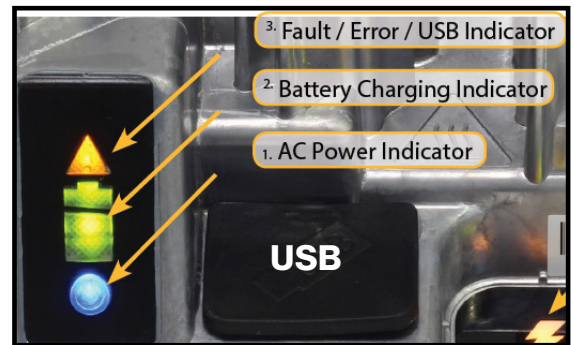
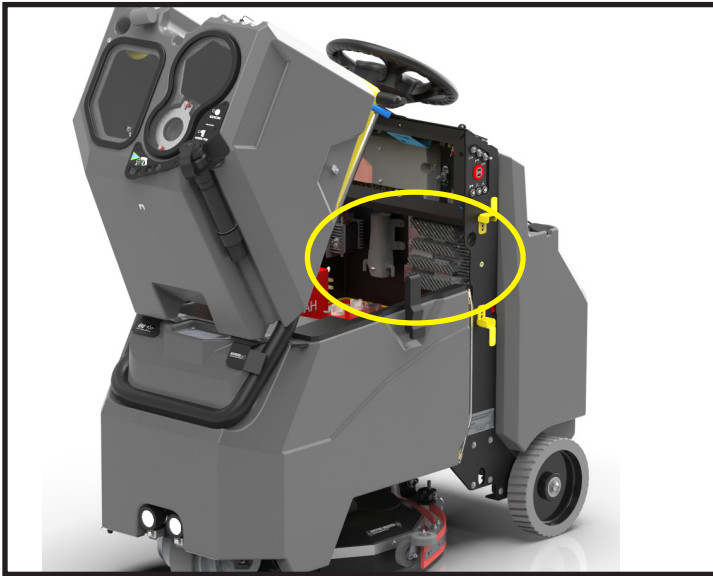
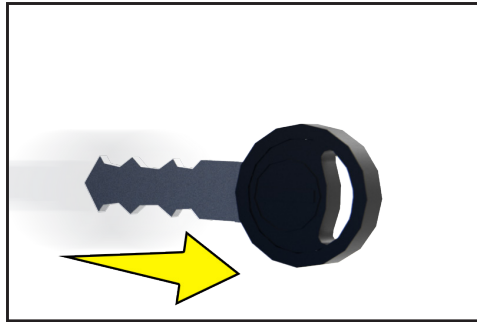

WEEKLY MAINTENANCE (OR 25 HRS)

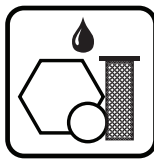

Clean White Filter/Screen

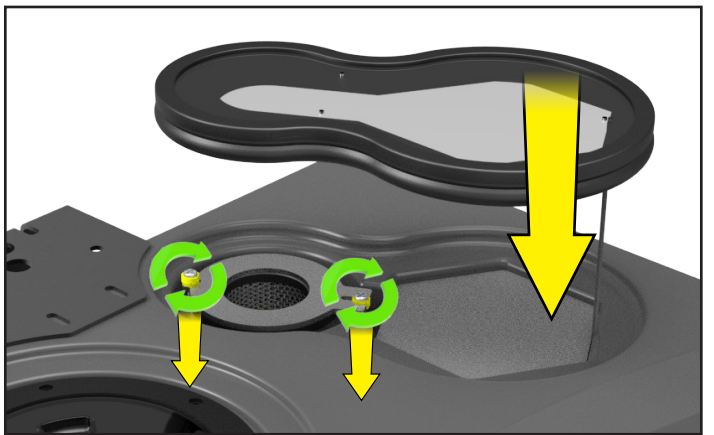
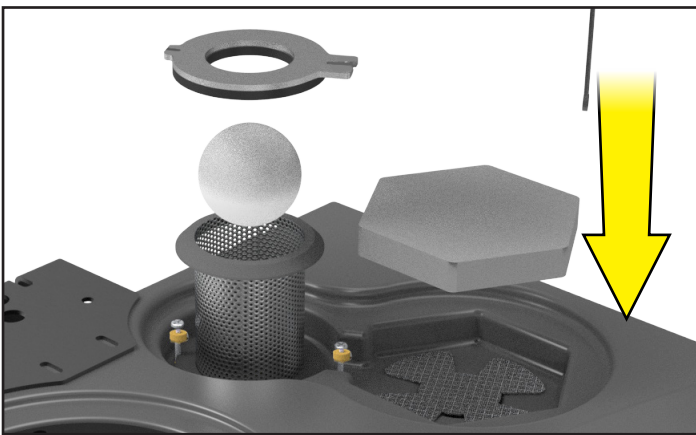
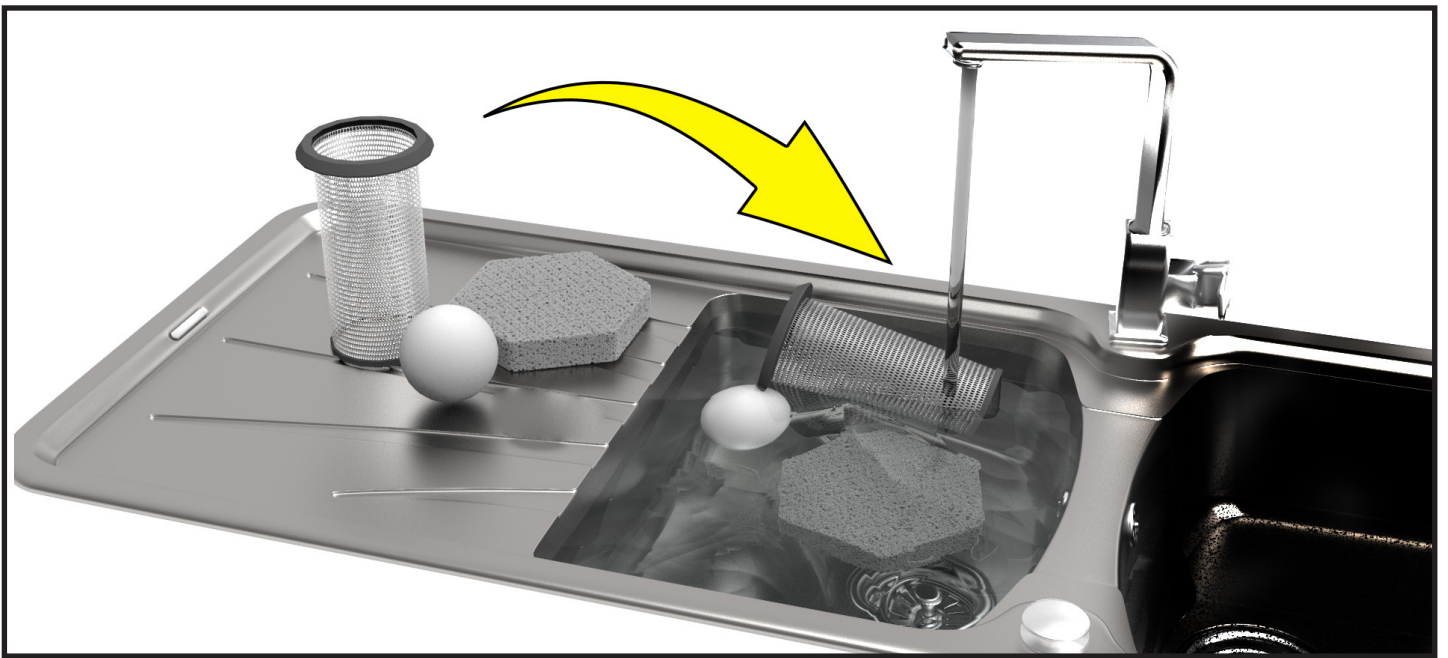
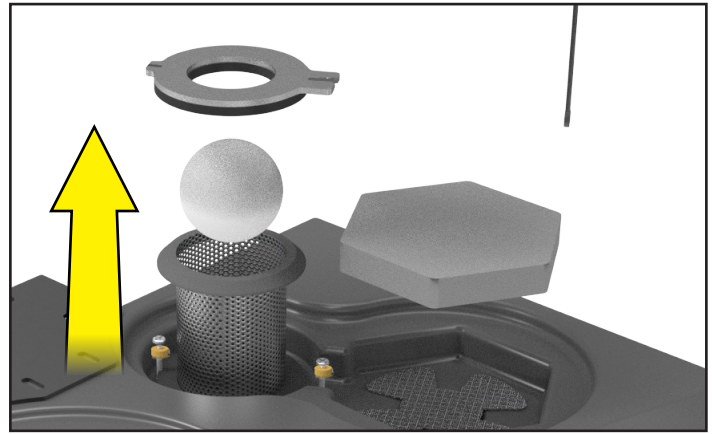
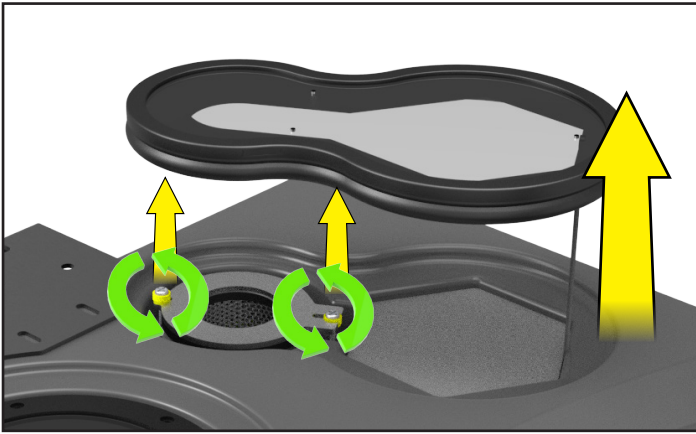



WEEKLY MAINTENANCE (OR 25 HRS)

Check Brush

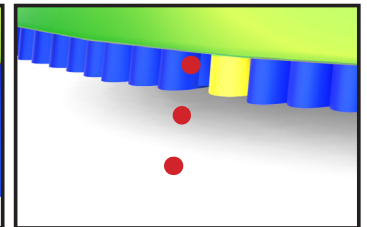
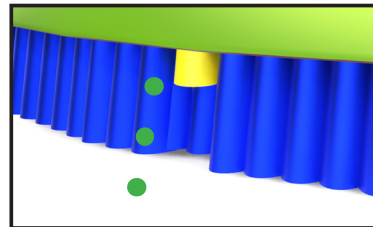
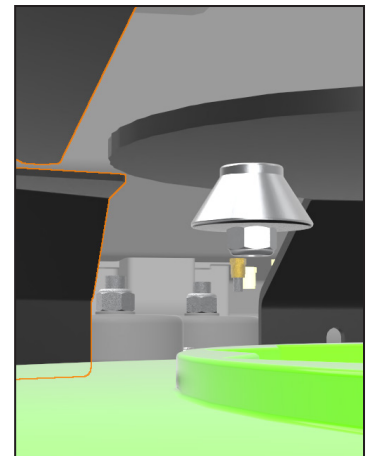
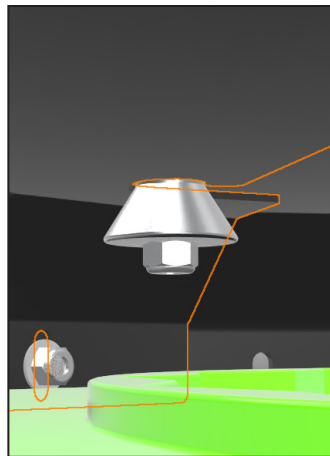
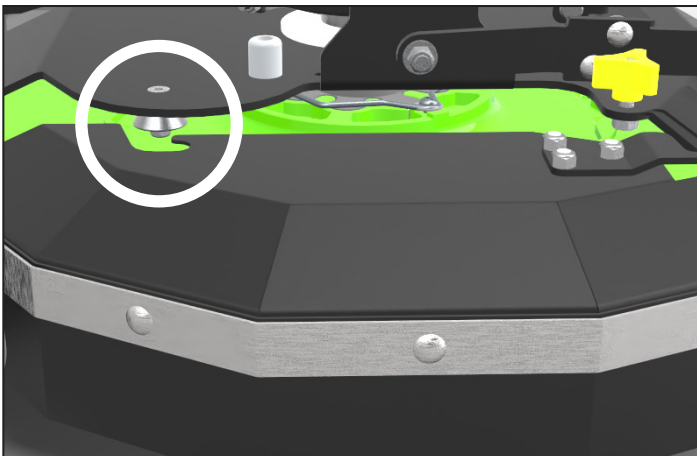
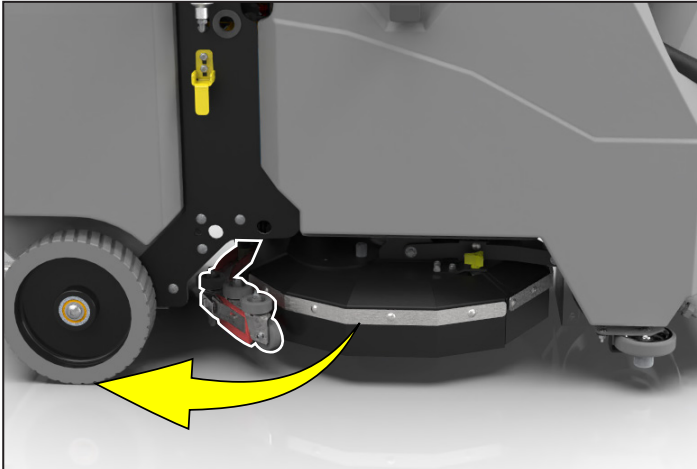
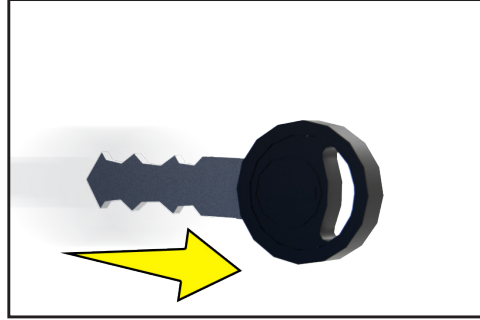

1/4" (0.5 cm)

WEEKLY MAINTENANCE (OR 25 HRS)

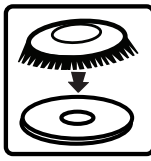

Check Pad

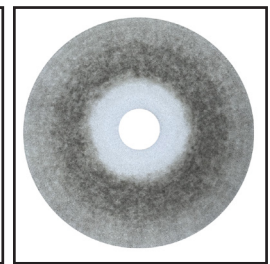
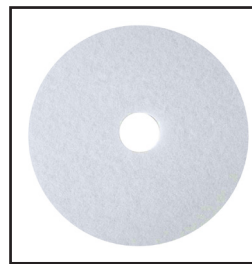
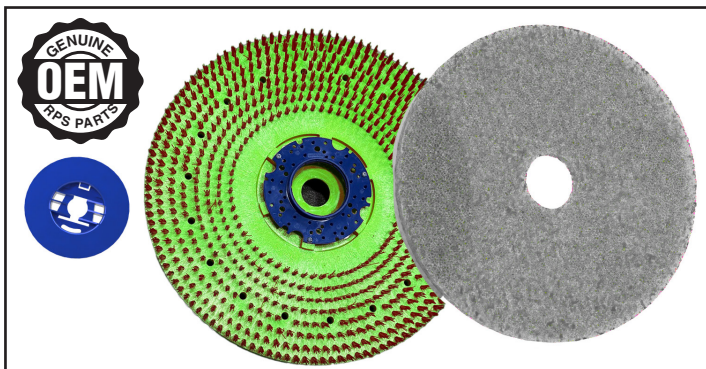
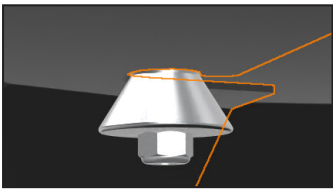
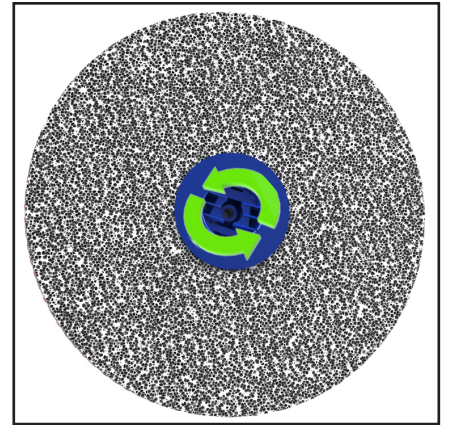
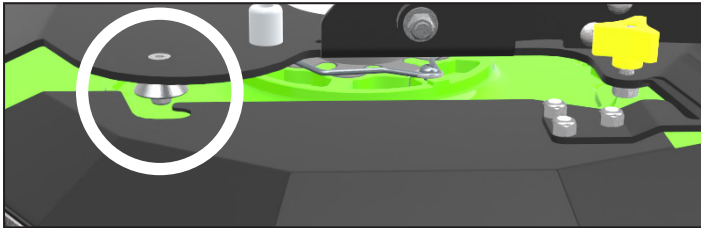
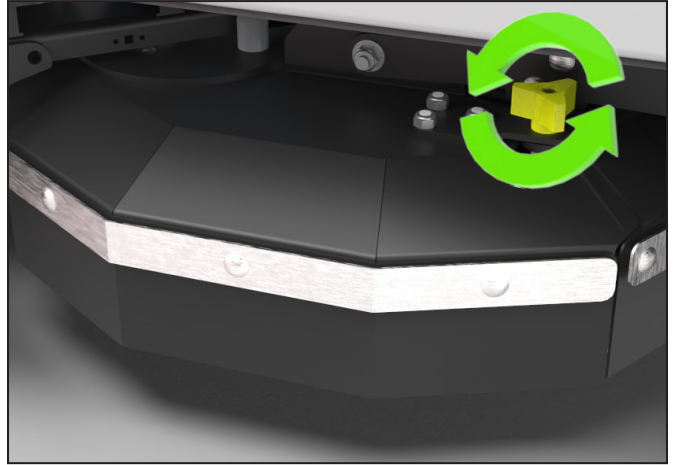
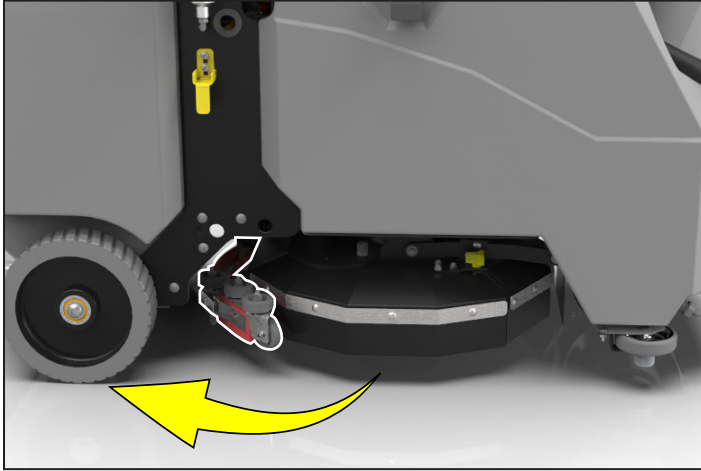
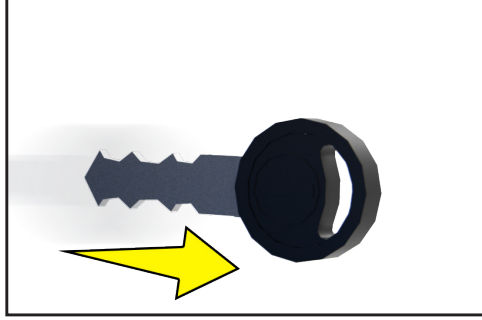
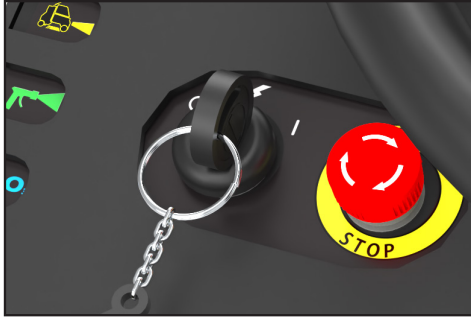

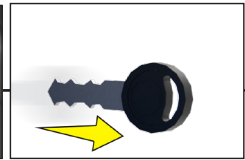
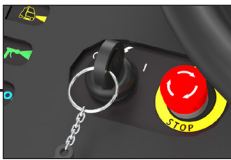

WEEKLY MAINTENANCE (OR 25 HRS)

Rotate Squeegee Blade

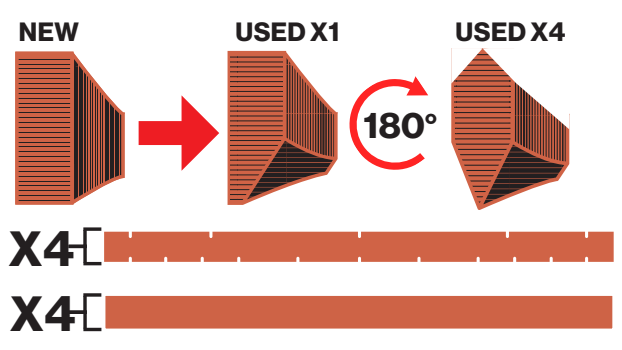
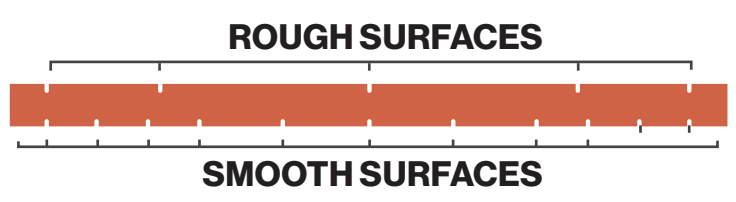
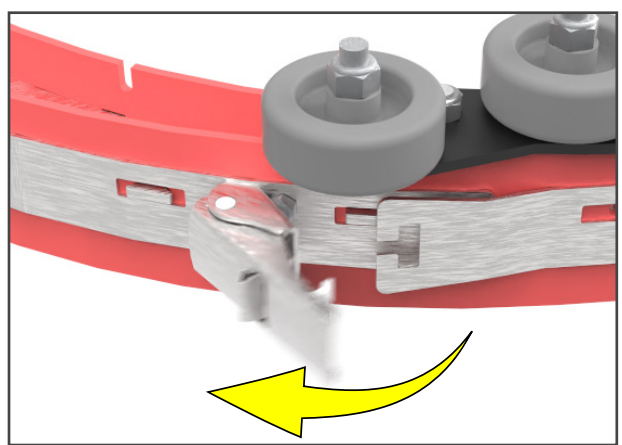
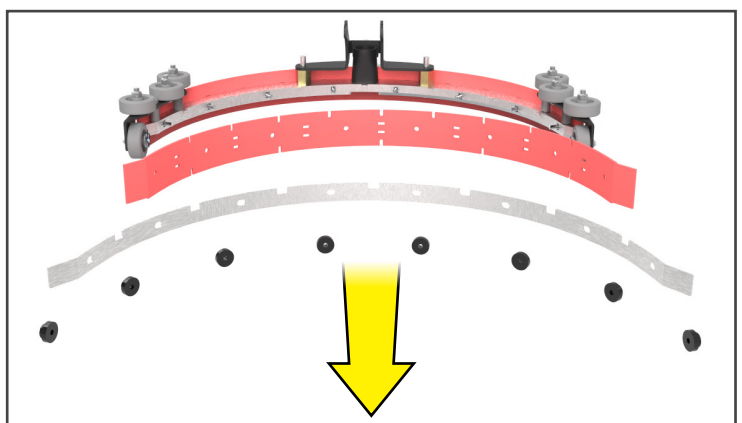
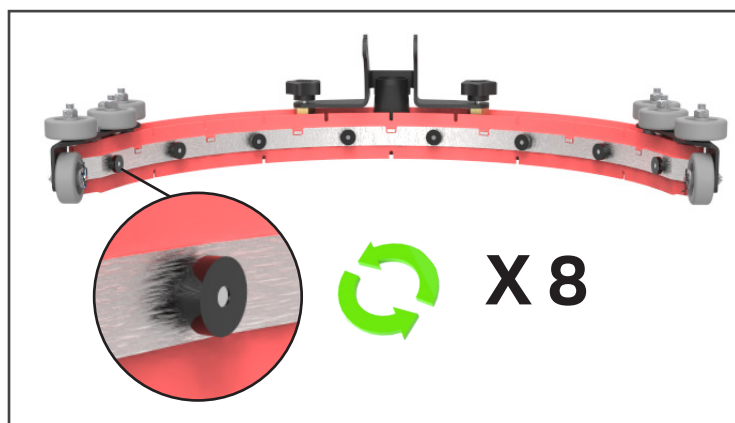
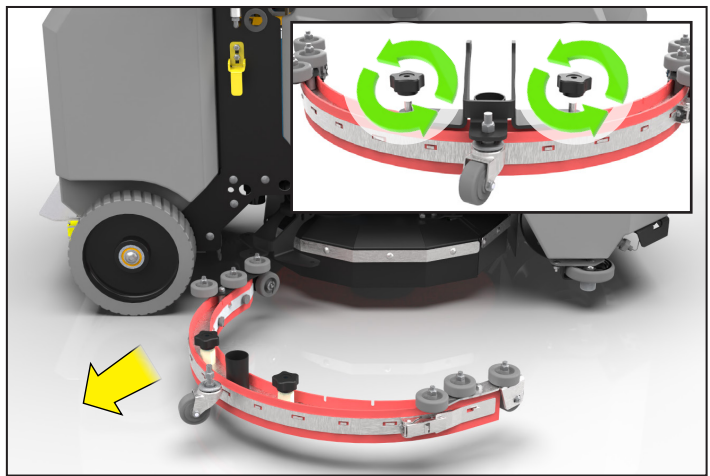
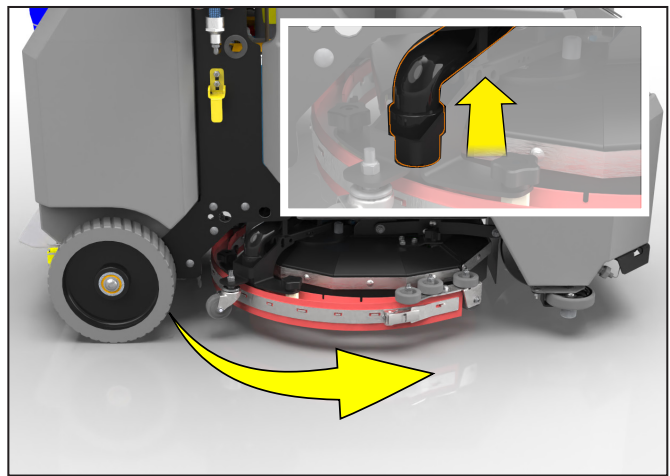

WEEKLY MAINTENANCE (OR 25 HRS)

Check ZER03 Air Dryer(Optional)

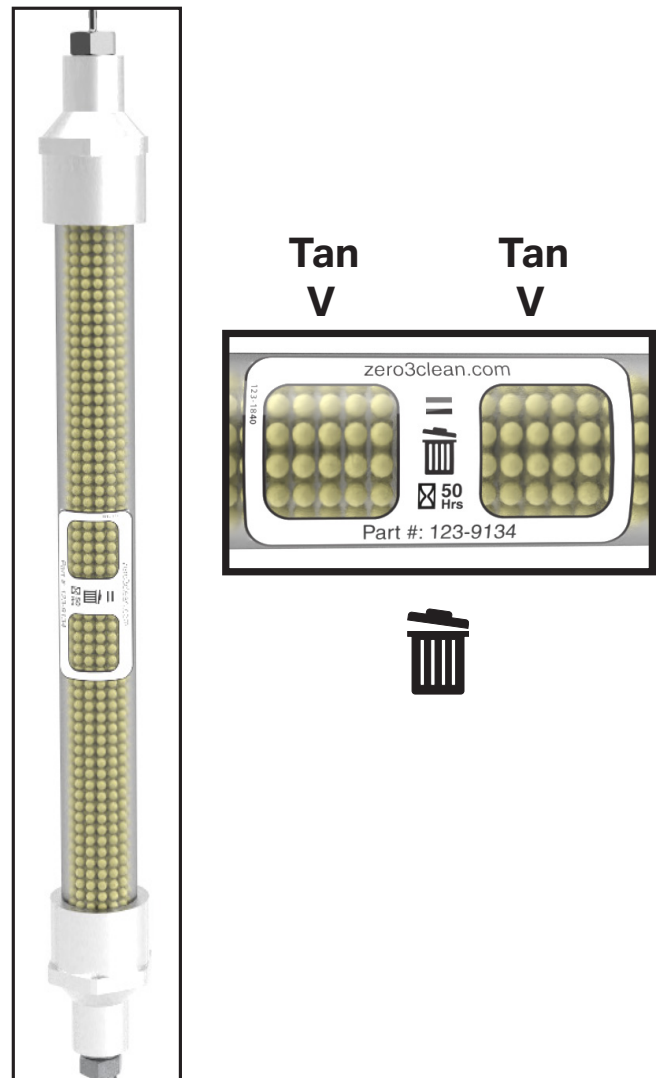
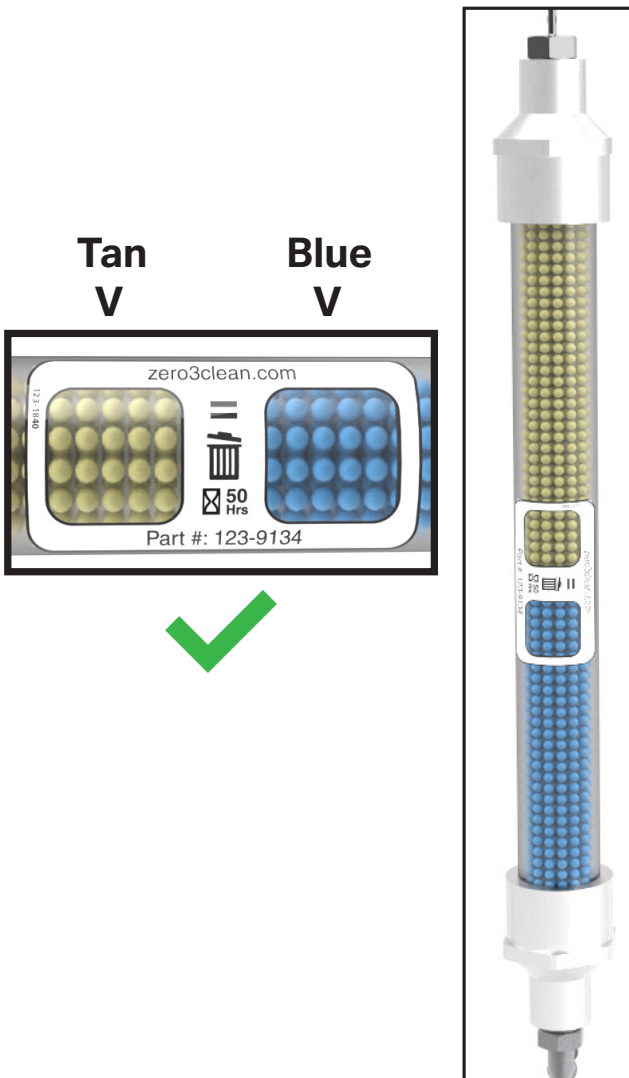
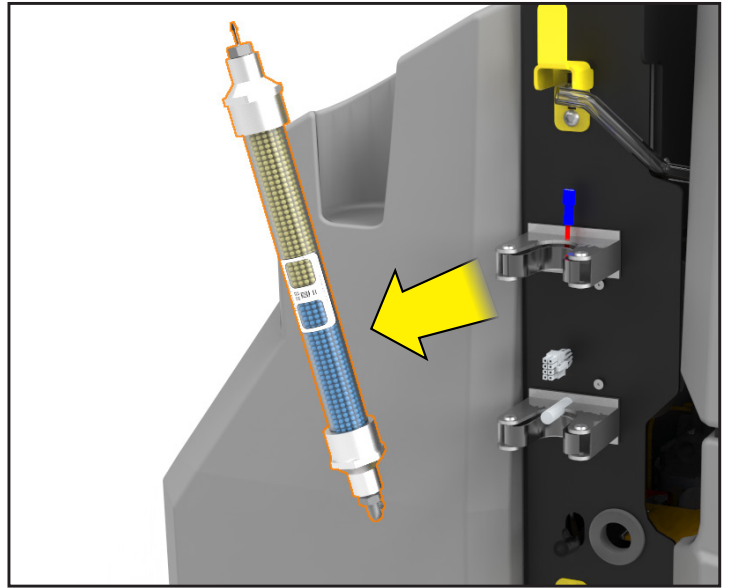
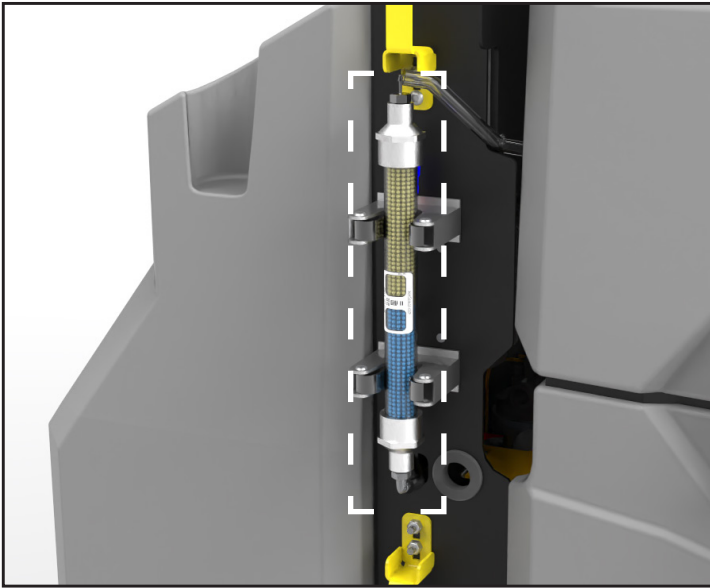
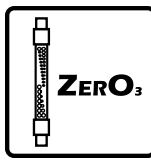



WEEKLY MAINTENANCE (OR 25 HRS)

Clean Solution Filter

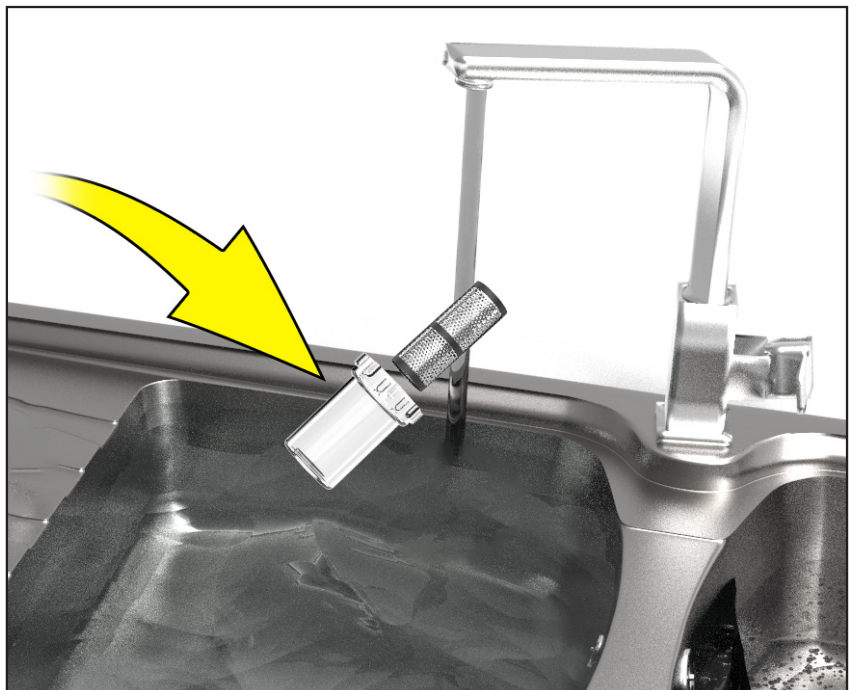
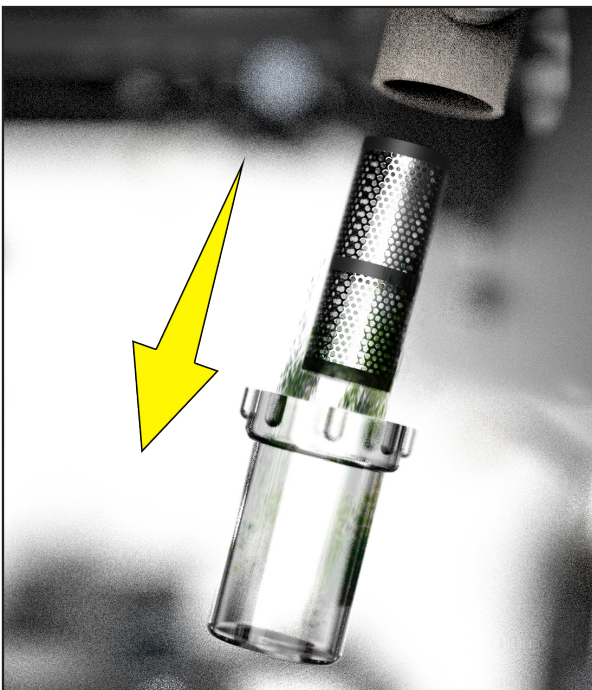
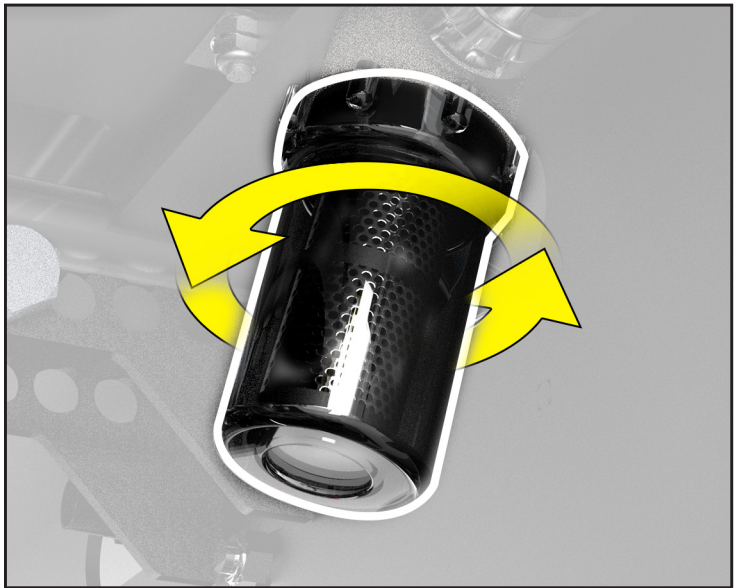
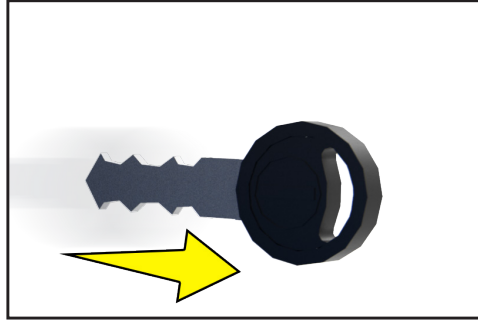

WEEKLY MAINTENANCE (OR 25 HRS)



Clean Spray Pump Filter

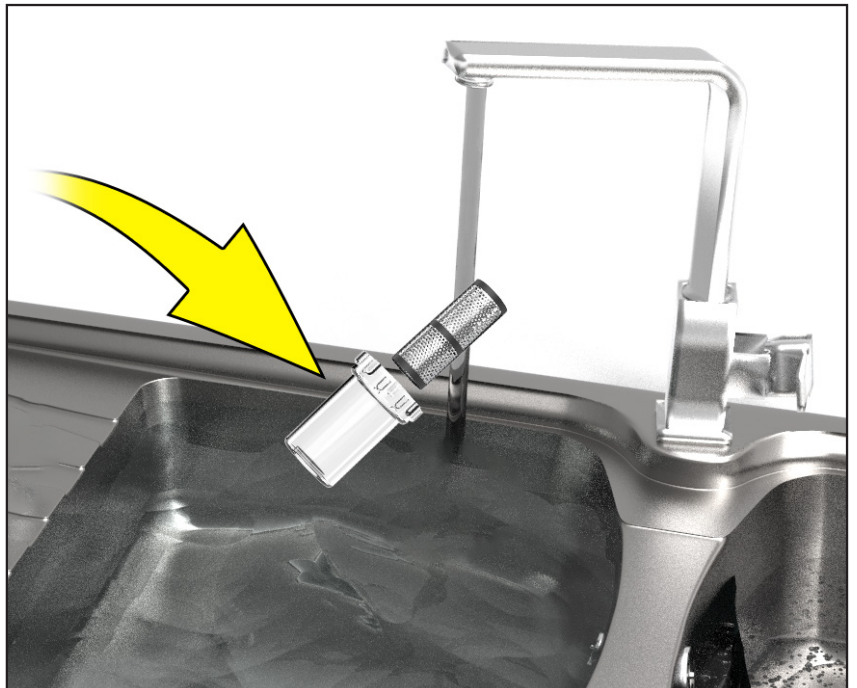
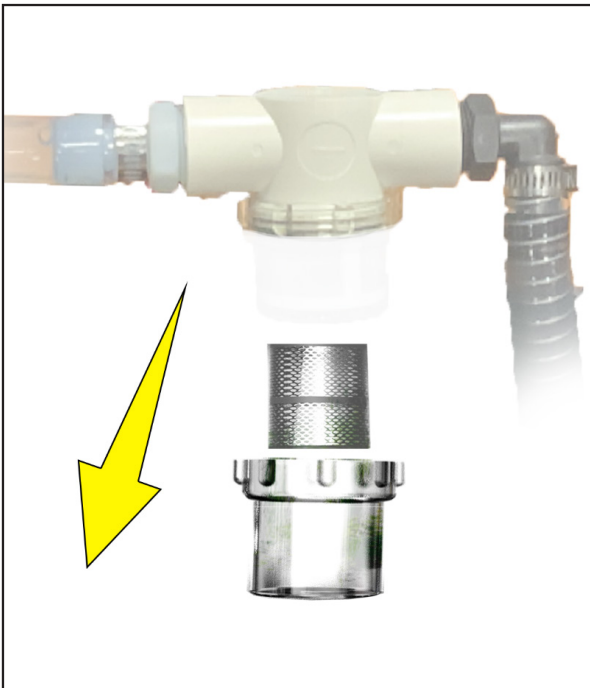
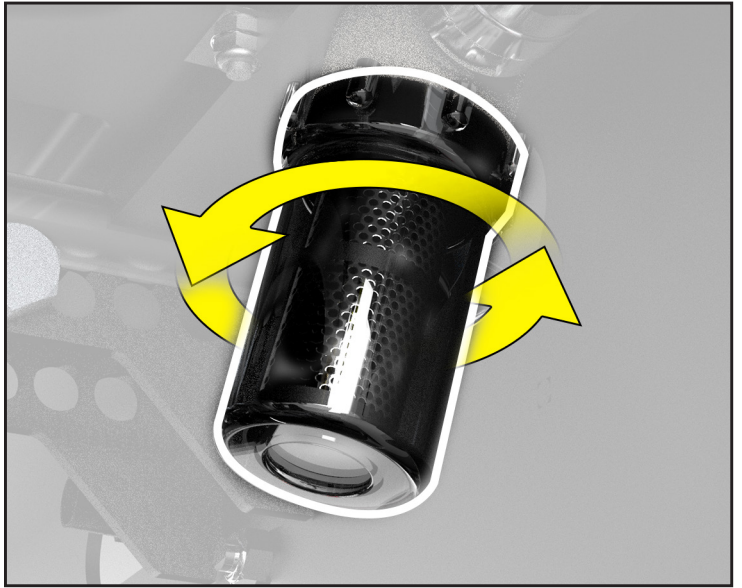
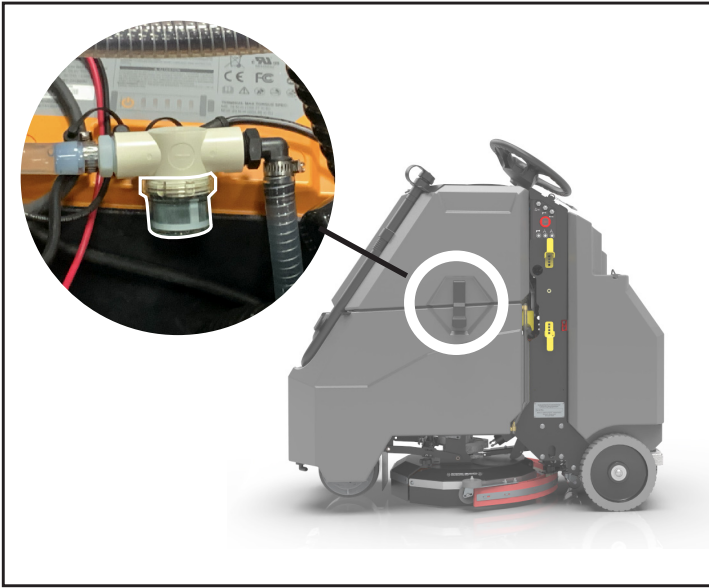
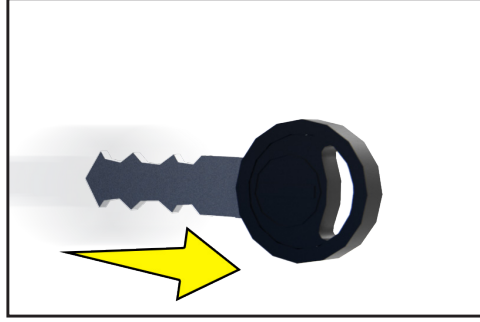



WEEKLY MAINTENANCE (OR 25 HRS)

Drain Solution Tank

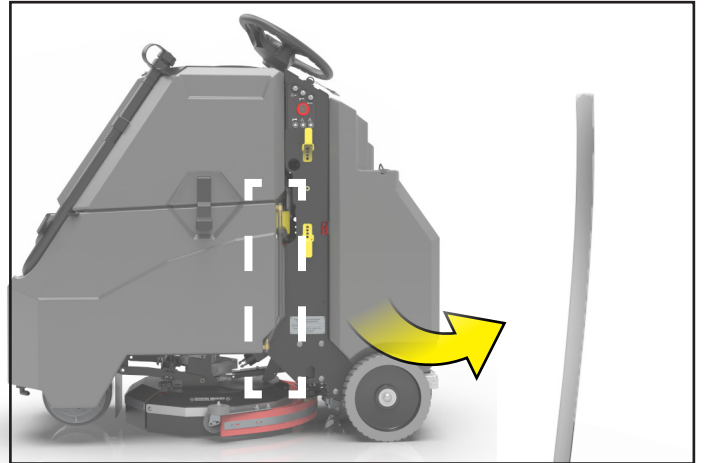
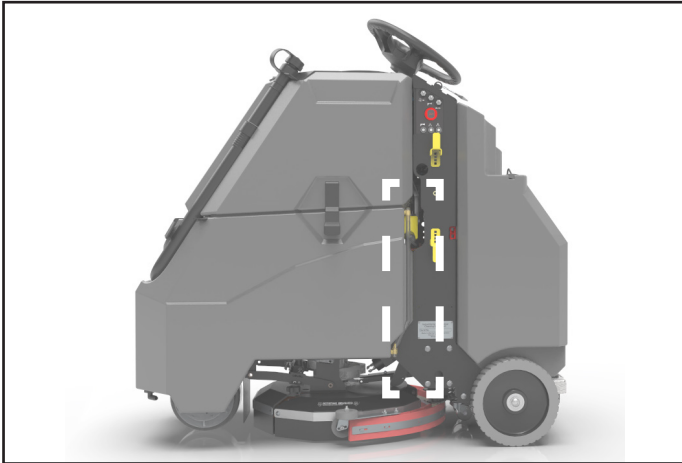

NOTICE

Drain "clean" Solution & "dirty" Recovery solution into APPROVED drains

MONTHLY MAINTENANCE (OR 100 HOURS)

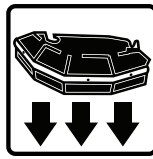

Adjusting Deck Curtains

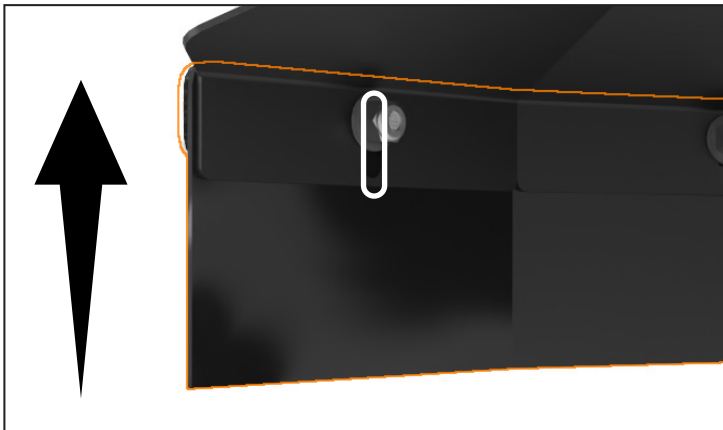
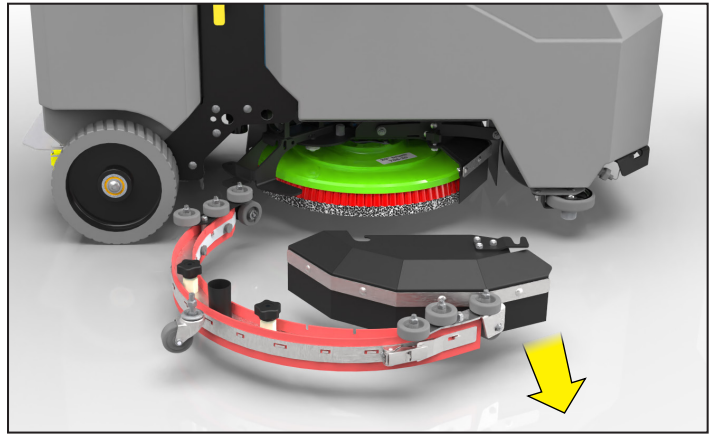
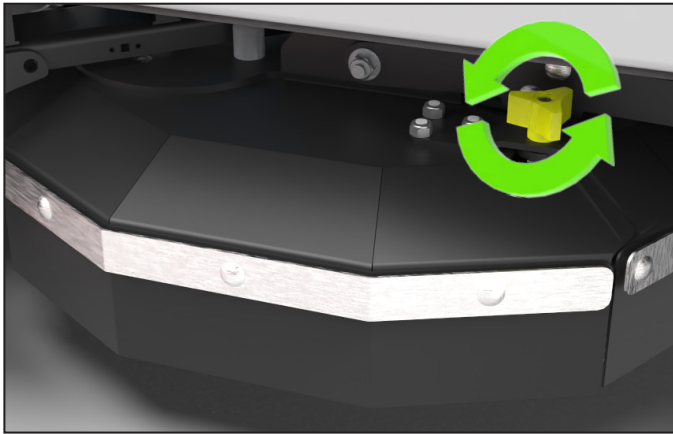
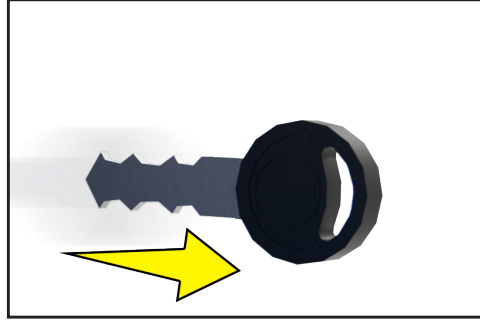

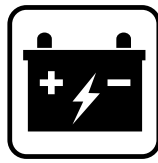

MONTHLY MAINTENANCE (OR 100 HRS)

Battery Water Level

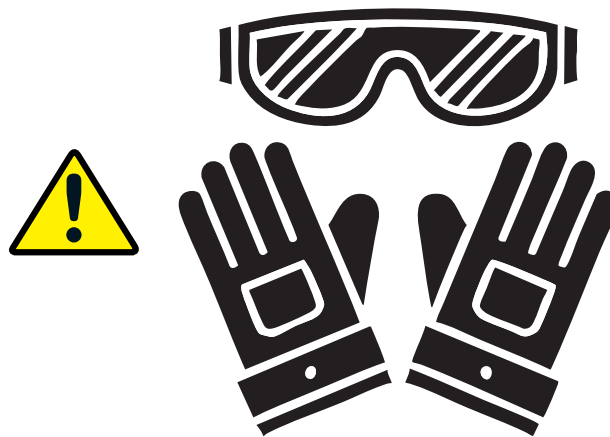
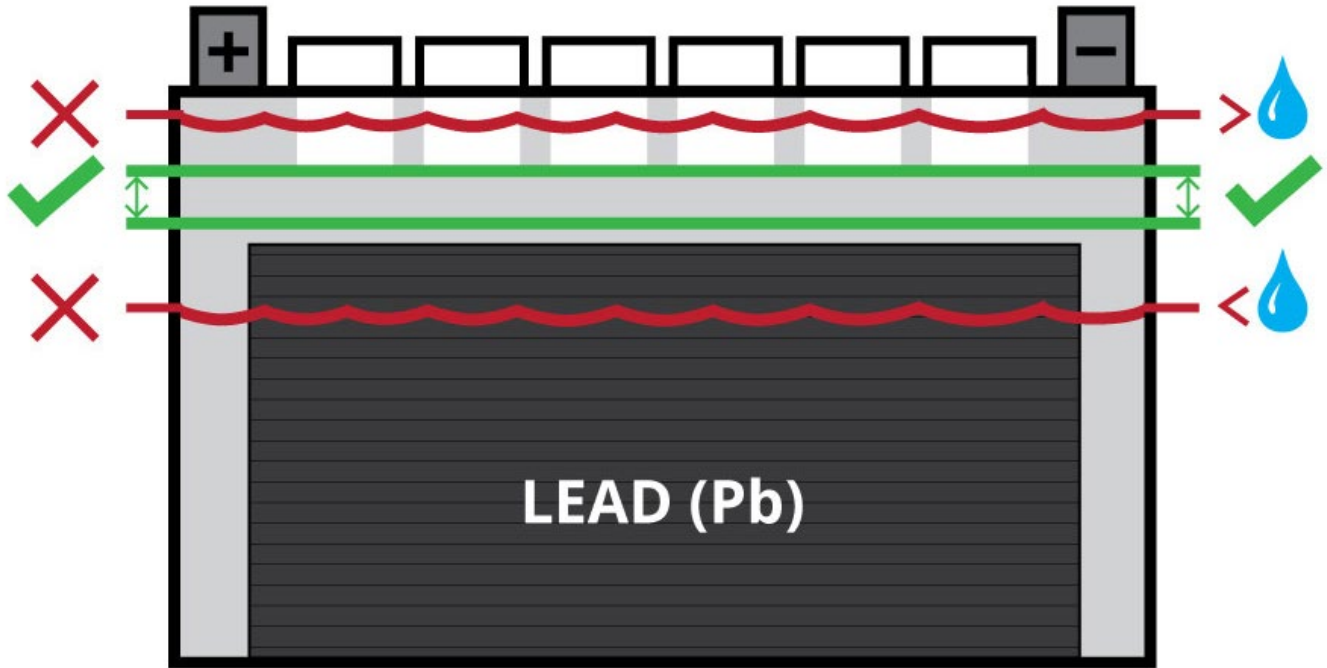



Tomcat Rival – PM Sheet

CUSTOMER & MACHINE INFORMATION				
Customer:			Email:	
Address:			Phone:	
City:	State:	Zip:	Contact:	
Serial #:	Model #:		Work Order #:	
Hour Meters	Key Switch:	Transportation:	Scrub Brush:	Vacuum:

NOTE: Start with Machine filled at least with 1/2 Tank of water. Turn ON Machine and Test Functionality of Machine

CHECK OPERATION & CONDITION OF	IN SPEC	REPAIR	PROBLEM
Key Switch			
Deck On / Off – Hold for Down Pressure +/-			
Solution On / Off – Hold for Water Level +/-			
Vac Button ON-OFF (Squeegee - Up/Down) – Hold for ECO			
Green Easy Go Button (Vac/Deck/Solution – On/Off)			
Service Screen Button (Hour Meters/Voltage/Amps)			
Drive Pedal + Dash Potentiometer			
Toggle Switch Forward/Reverse			
Horn			
E-Stop			
Operator Presence Switch			

NOTE: Drain Solution & Recovery Tank fully. Rinse out Recovery Tank

CLEAN & INSPECT – SOLUTION TANK	IN SPEC	REPAIR	PROBLEM
Solution Fill Hose			
Solution Inline Filter			
Battery Drain Hose			

BRUSH CONDITION – SCRUB DECK			
Deck Curtains	Good	Worn	Needs Replacement
Brush Or Pad Driver Sockets:	Good	Worn	Needs Replacement
Decks Brush Drivers:	Good	Worn	Needs Replacement
Scrub Brush Fiber Length	Brush 1 Length:	Brush 2 Length:	Rotated Brushes: Y / N
Orbital Deck Grip Face	Good	Worn	Needs Replacement

CLEAN & INSPECT – SCRUB DECK	IN SPEC	REPAIR	PROBLEM
Scrub Deck Linkage Pivot Points			
Scrub Deck Lift Actuator			
Scrub Deck Level			

CLEAN & INSPECT - SQUEEGEE	IN SPEC	REPAIR	PROBLEM
Remove and Wipe off Squeegee			
Check and Rotate Blades as Needed			
Caster Wheels and Height			
Pitch Adjust			
Check Pivot, Knobs & Swing Travel			
Squeegee Vac Hose			

CLEAN & INSPECT – RECOVERY TANK	IN SPEC	REPAIR	PROBLEM
Recovery Tank Lid & Gasket			
Recovery Tank Support Cord			
Vacuum Float Ball Screen & Gasket			
Vacuum Box White Filter Clean			
Recovery Drain Hose			
Unloader Valve			

CLEAN & INSPECT – DRIVE	IN SPEC	REPAIR	PROBLEM
Drive & Wheels Condition			
Parking Brake engaged when machine off			

CLEAN & INSPECT - OPTIONS	IN SPEC	REPAIR	PROBLEM
Disinfectant Pump Filter			
100 psi Spray wand			
Dual Head Lights			
ZerO3 Air Dryer			
Charger Output Voltage			Voltage Reading []

V25090



Tomcat Rival – PM Sheet

CLEAN & INSPECT - OPTIONS	IN SPEC	REPAIR	PROBLEM
Battery Terminals			
Battery Cables			
Torque Battery Nuts 11ft/lbs			

OPERATE & CONFIRM	IN SPEC	REPAIR	PROBLEM
Fill Solution Tank – ¾ Full			
Scrub & Dry			
Fine Tune Squeegee Adjustments			

NOTE: ENSURE TO CHECK YOUR WET LEAD ACID BATTERIES, LITHIUM/AGM BATTERIES ONLY REQUIRE THE CHECKS ABOVE.

BATTERY #1	HYDROMETER READING	WATER CLARITY (Circle One)		WATER LEVEL (Circle One)		
Cell A		Clear	Dark	Overfilled	Full	Low
Cell B		Clear	Dark	Overfilled	Full	Low
Cell C		Clear	Dark	Overfilled	Full	Low
Cell D (12v only)		Clear	Dark	Overfilled	Full	Low
Cell E (12v only)		Clear	Dark	Overfilled	Full	Low
Cell F (12v only)		Clear	Dark	Overfilled	Full	Low

BATTERY #2	HYDROMETER READING	WATER CLARITY (Circle One)		WATER LEVEL (Circle One)		
Cell A		Clear	Dark	Overfilled	Full	Low
Cell B		Clear	Dark	Overfilled	Full	Low
Cell C		Clear	Dark	Overfilled	Full	Low
Cell D (12v only)		Clear	Dark	Overfilled	Full	Low
Cell E (12v only)		Clear	Dark	Overfilled	Full	Low
Cell F (12v only)		Clear	Dark	Overfilled	Full	Low

BATTERY #3	HYDROMETER READING G	WATER CLARITY (Circle One)		WATER LEVEL (Circle One)		
Cell A		Clear	Dark	Overfilled	Full	Low
Cell B		Clear	Dark	Overfilled	Full	Low
Cell C		Clear	Dark	Overfilled	Full	Low

BATTERY #4	HYDROMETER READING G	WATER CLARITY (Circle One)		WATER LEVEL (Circle One)		
Cell A		Clear	Dark	Overfilled	Full	Low
Cell B		Clear	Dark	Overfilled	Full	Low
Cell C		Clear	Dark	Overfilled	Full	Low

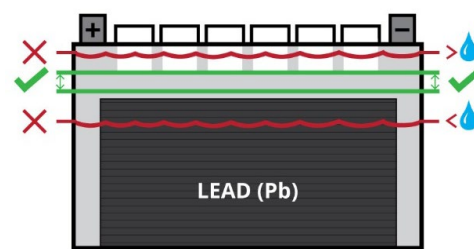
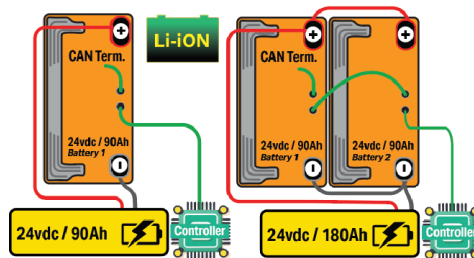
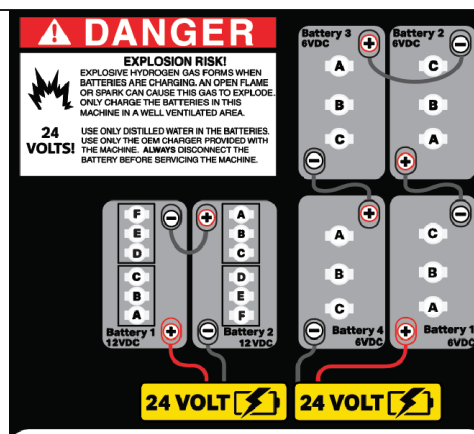

COMMENTS & RECOMMENDATIONS		
Servicing Distributor:		
Technician's Name:	Date:	Signature:
Customer's Name:	Date:	Signature:

V25090

OTHER

Battery Chargers

Optional Console / WET / Domestic Chargers:

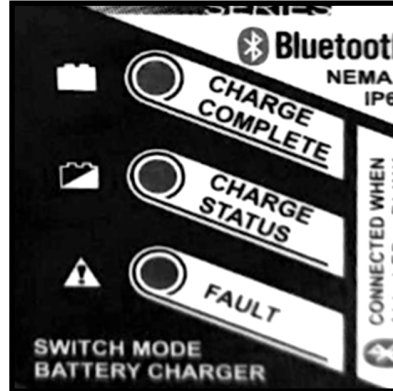

AC Power IN: 120VAC / 60Hz
DC Power OUT: 24VDC / 27A

Please refer to OEM Charger Operating Instructions for more information.



Standard Onboard / AGM / International Chargers:

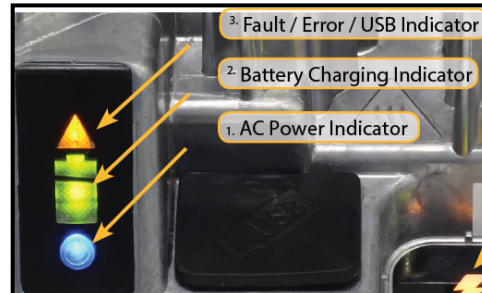
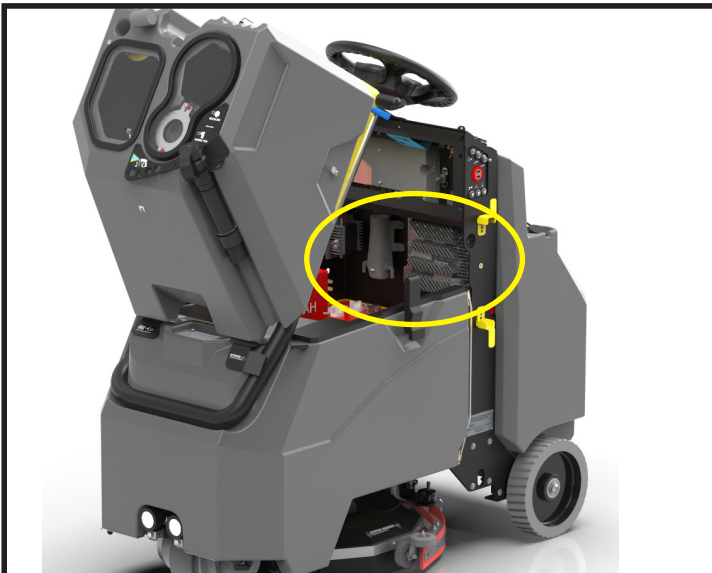

AC Power: 80-270VAC / 50-60Hz
DC Power OUT: 24VDC / 27A + 37A

Please refer to OEM Charger Operating Instructions for more information.



When there is some kind of malfunctioning, the display can show an error with a short description of it.

Whether the error is non-blocking (warning) or blocking, it is displayed as a single line of text in the upper part of the main screen, overriding the hour counter

Following there is the full list of errors and warnings that can appear on the display.

Such errors are divided in 2 tables showing first the blocking ones and non-blocking (warning) next.

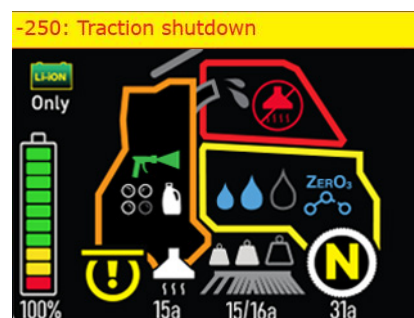

Figure 5: Alarm and warning screen example

ERROR NUMBER	ERROR TYPE	ERROR DESCRIPTION	POSSIBLE SOLUTION
3	Blocking	The machine detected too high voltage coming from the battery cables and halted the functions	Check that the battery or the supply of power is around the range of 24V and restart the machine
4	Blocking	The machine detected voltage too low to function correctly and halted the functions	Check that the battery is correctly charged before using it and restart the machine
7	Blocking	The machine detected that the battery is charging and halted the functions	Take out the charging cable before using the machine
10	Blocking	It has passed too much time since someone touched the machine and it has entered the standby mode	Restart the machine
211	Blocking	The Orion detected the potentiometer out of the allowed range	Check the potentiometer cables and the parameters value
214	Blocking	The Orion detected a temperature too high on the motors and halted the functions	Make the machine cool down for a bit and check the Orion board for any possible issue that could cause a temperature rising
230	Non blocking	There is some condition preventing the machine from starting, depending on which controls are enabled at startup	Release the pedal or the OPC input
40, 240	Blocking	There are issues between the Orion and Display CANbus communication	Check the CANbus cable and the resistance parameter on each board
250	Blocking	The traction drivers detected a current spike too high and halted the functionalities related to said motor	Check the cable and the motor itself and restart the machine
251	Blocking	The traction maximum current was too high for too much time and the functionalities were halted	Check the motor and the cables as well as the I2T parameters if everything is correct and restart the machine

OTHER

Membrane

253	Blocking	The traction current limitation went on for too much time and the functionalities were halted	Check if the current parameters are correct and restart the machine
254	Blocking	The Orion did not detect the traction motor at startup	Check the wirings and restart the machine
256	Blocking	The battery reached its minimum value of charge and the traction was halted to prevent wearing	Recharge the battery
290	Non blocking	The brushes drivers detected a current spike too high and halted the functionalities related to said motor	Check the cable and the motor itself and restart the machine
291	Non blocking	The brushes maximum current was too high for too much time and the functionalities were halted	Check the motor and the cables as well as the I2T parameters if everything is correct and restart the machine
293	Blocking	The brushes current limitation went on for too much time and the functionalities were halted	Check if the current parameters are correct and restart the machine
296	Non blocking	The battery reached its minimum value of charge and the brushes were halted to prevent wearing	Recharge the battery
310	Non blocking	The vacuum drivers detected a current spike too high and halted the functionalities related to said motor	Check the cable and the motor itself and restart the machine
311	Non blocking	The vacuum maximum current was too high for too much time and the functionalities were halted	Check the motor and the cables as well as the I2T parameters if everything is correct and restart the machine
313	Blocking	The vacuum current limitation went on for too much time and the functionalities were halted	Check if the current parameters are correct and restart the machine
316	Non blocking	The battery reached its minimum value of charge and the vacuum was halted to prevent wearing	Recharge the battery

BLANK

THIS PAGE WAS INTENTIONALLY LEFT BLANK

